

# Practical Computing

An ECC Publication. Volume 2 Issue 2

February 1979

**Cromemco Z-2D  
under the  
microscope**

**Microcomputer  
systems for  
doctors and  
estate agents**

**Pet Corner**

**Putting payroll  
on a computer**

**Low-cost  
peripherals**

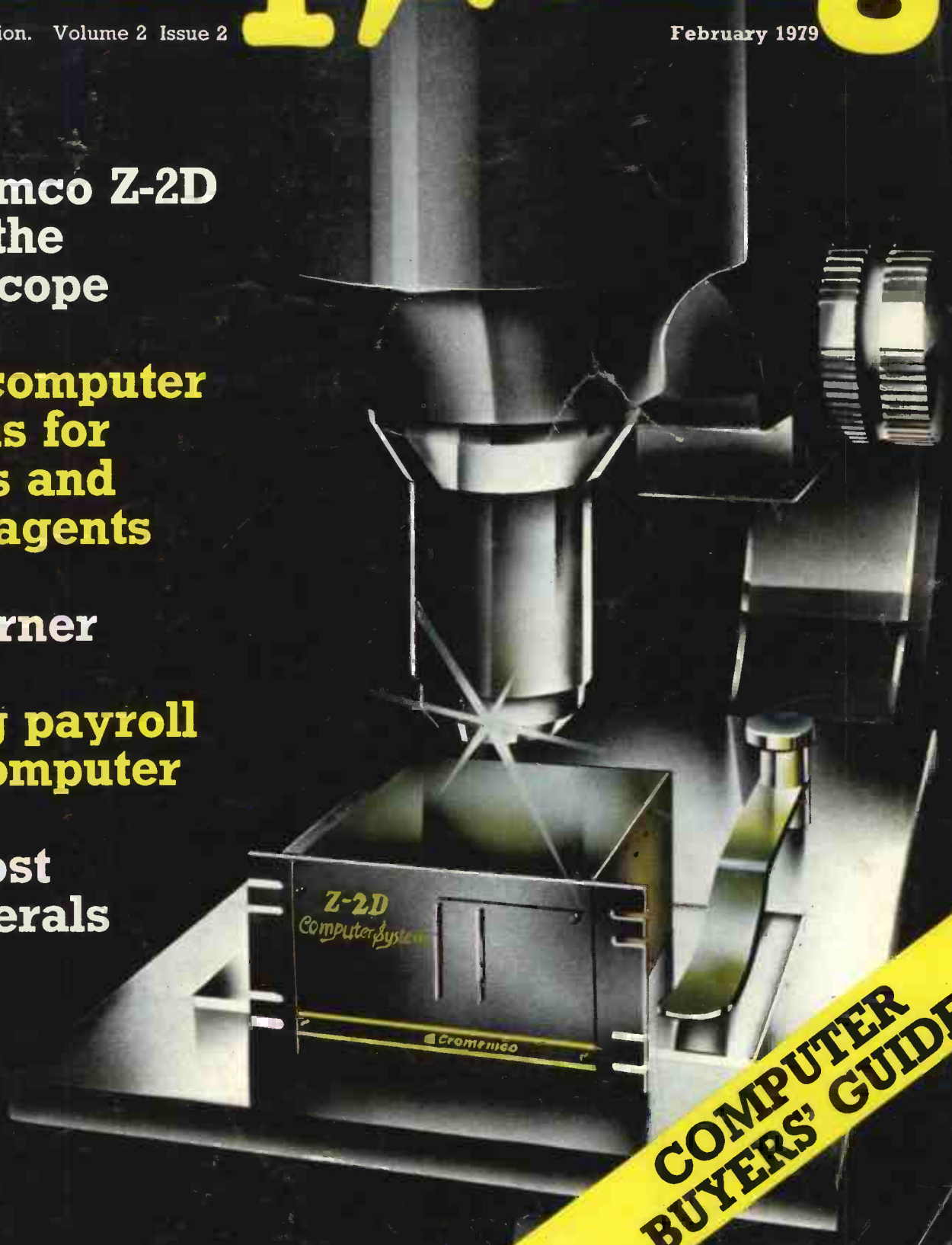

**COMPUTER  
BUYERS' GUIDE**

# After you've been chased by rhinos and have met the hangman, it's time to learn a thing or two...

One lesson you'll have to learn on your own - how to tear yourself away from your computer in the early hours. Infoguide provides you with a new concept in recreational, educational and business software.

## You'll probably start in the Playgroup.

Insert your Compusette, and there's the Hangman to challenge.



Or Rhino - a progressively harder chase through the jungle, where you're never sure what's going to happen next.

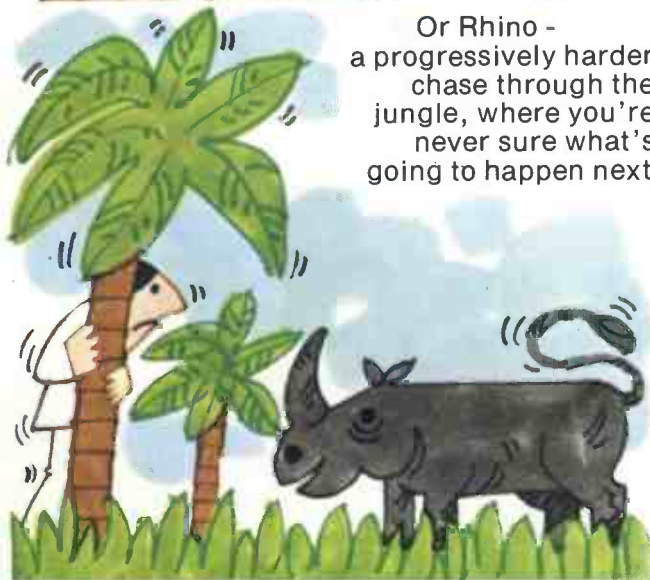

Insert other Compusettes, and ...

## Middle School

could see you taking your computer on at Mastermind. Or Go!



## High School

sees you and your computer working on statistical programmes. Conversion. Financial management. Forecasting. These - and many other functional programs - are on Compusette.

## At Degree Level,

why not simulate an enzyme reaction? Change any one (or more) of six parameters and see what happens? Maybe discover, when playing chess, that your computer is a Grand Master? A Compusette will supply each of the necessary programs. An interesting variety of Compusettes are being made available for PET, Apple II and TRS 80. Each is accompanied by a fully detailed booklet with listings of the programs - there are up to three on each tape. You will find that most dealers handling personal computers will be stocking the Compusette range. Ask your dealer now.

For as little as £2.70 per program\* - that's value!

# COMPUSSETTES

Compusettes are produced by Infoguide Ltd, 142 Wardour Street, London W1. 120 El Camino Drive, Suite 108, Beverley Hills, Cal 90212 USA

\* Based on three programs on an £8.00 Compusette.

Managing Editor  
**Dennis Jarrett**

Computabits Editor  
**Nick Hampshire**

Production Editor  
**Harold Mayes**

Advertisement Manager  
**Erica Gibson**

Advertisement Representative  
**Tom Moloney**

Subscription Manager  
**Annabel Hunt**

Publisher  
**Wim Hoeksma**

Company Secretary  
**Carole Fancourt**

Managing Director  
**Richard Hease**

Editorial, Advertising and  
subscriptions: 01-278 9517.

Practical Computing is published  
by ECC as a subsidiary of  
WHICH COMPUTER? Ltd at its  
registered office, 2 Duncan  
Terrace, London, N1, and printed  
by Bournehall Press Ltd,  
Welwyn Garden City. Distributed  
by Moore Harness Ltd, 31 Corsica  
Street, London, N5.

© Practical Computing 1978  
ISSN 0141-5433.

Subscription rates: Single  
copy: 50p. Subscriptions: U.K., £6  
per annum (including postage);  
overseas, £12 (including airmail  
postage).

Every effort has been made to  
ensure accuracy of articles and  
program listing. Practical  
Computing cannot, however,  
accept any responsibility  
whatsoever for any errors.

## CROMEMCO REVIEW

We put the Cromemco Z2-D under the microscope to test its capabilities.

Page: 31

## SYSTEMS FOR ESTATE AGENTS & DOCTORS

A look at some of the systems available for holding either patient or property records and how much they cost.

Page: 27

## PROCESSING THE PAYROLL

Setting-up a payroll system is not so difficult. We report how you can do it for less than £1,000.

Page: 35

## PET CORNER

A new monthly column which shows how users are making the most of the Pet, with ideas for you.

Page: 28

## LOW-COST PERIPHERALS

The cost of visual display terminals and printers is one of the handicaps of buying a cheap system. We look at the problem.

Page: 38

## BUYERS' GUIDE

Comprehensive guide to micros on the British market, with details of prices, configurations and applications.

Page: 60

## AND MUCH MORE

Computabits looks at moving programs, bubble sorts, and games, page 67; Feedback, page 19; Printout, page 25; Micros at Longfield School, page 40; Cambridge Computer Store, page 45; Warlock Warren—a game, page 46; Illustrating Basic, page 51; Standards for tape cassettes, page 59; Play noughts and crosses, page 65; Glossary, page 78.

**ORDER BY POST  
FROM THE WIDEST  
RANGE OF  
MICRO-COMPUTERS  
IN BRITAIN...  
OR VISIT OUR  
STORES**

# the **BYTE** SHOP Ltd

**IT'S  
APPLE  
EX-STOCK** 

## SOUTHWEST TECHNICAL PRODUCTS — FOR 6800 USERS

MP-68CPU, 4K RAM	£355
8K additional RAM	£140
560KB twin disk system	£1,400
160KB twin mini floppy system	£860
CT-64 V.D.U. upper/lower case, monitor	£455
PR-40 40-column printer	£250
Cassette interface	£100
GT-61 Graphics Terminal	£105

A favourite with schools and colleges — low priced system that can grow.

Attractive low-priced software!

## FOR THE PROFESSIONAL — CROMEMCO

Z-2 system: fully assembled	£575
Z-2 system: Kit	£395
Disk system from	£1,425
CS-3 System 3, 32K, dual disk, expandable	£4,175
4 MHz Single card computer	£345
Bytesaver board with PROM Programmer	£135
16K PROM card	£135
Analogue Interface	£135
Disk — BASIC, FORTRAN, ASSEMBLER, COBOL, etc. etc.	each — £85

A rugged well-engineered system designed for hard use. Expandable to 512K, 21 Boards. Excellent software support CP/M AVAILABLE

## PROCESSOR TECHNOLOGY SOL 20/16

Computer system, 16K, V.D.U. etc.	£1,785
Additional memory, 16K dynamic	£275
Mini-floppy disk (first)	£635
High quality word processing printer from	£1,800

A quality 8080 based system. Over 7,000 sold! Excellent word processing software available.

Also... Printers for all the above systems... extra software... diskettes... cassettes... Chess Challenger 10... games... etc.

Branches in Nottingham, Tottenham Court Road — London, Birmingham, Manchester & Glasgow.

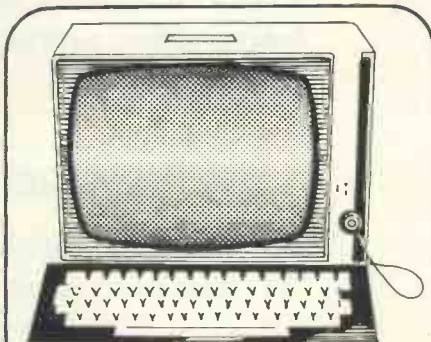

## THE BYTE SHOP V.D.U.

16 x 64 Display	
Upper/Lower Case	
Separate Keyboard	
Clear 7 x 9 Dot Matrix	
British Design & Manufacture	
CC1TTV24 or Current loop interface	£359
VDU without keyboard	£299

## BOOKS GALORE!

Introduction to Microcomputers Vol. 0	£5.95
Vol. 1. Basic Concepts	£5.95
Vol. 2. Some Real products	£11.95
Some Common BASIC Programs	£5.95
Instant BASIC	£7.50
Understanding microcomputers	£7.95
Your Home computer	£4.95
6800 Assembly language programming	£6.95
808A Assembly language programming	£6.95
Z-80 programming for logic design	£5.95
etc. etc.	

Also most U.S. magazines available. Personal Computing, BYTE, Interface Age, Dr. Dobbs etc.

## NORTH STAR COMPUTER PRODUCTS

Horizon-1 system, 16K, 1 mini floppy	£1,265
Additional mini floppy	£325
Additional 16K static memory 4MHZ	£315
Printer interface	£70
Extended BASIC and DOS included in above	

Release 4 BASIC & DOS	£25
CP/M Horizon	£130

A value-for-money system using the advanced Z-80 clip and S100 Bus.

## COMMODORE SYSTEMS

Pet personal computer, including V.D.U. BASIC interpreter + 8K user memory Built-in cassette, ready-to-go... £643.52  
Pet 2nd cassette deck... £55.00  
Pet software, large selection, from... £3.00  
Joystick, video monitor attachment, now available!  
Expander printer, Pet interface and power supply... £414.00  
A very popular and adaptable system, excellent value!

KIM-1 system 2K ROM, 1K RAM etc.	£149.00
KIM-3 additional 8K RAM	£179.00
KIM-4 Motherboard	£89.00
KIM-5 Assembler and Editor	£129.00



Send for FREE catalogue

## MAIL ORDER

Please send me .....

(if preferred, attach order on separate sheet to coupon)

Name .....  
Address .....

I enclose cheque for £ .....  
 Please debit my Diners Club/  
American Express/Access/Barclaycard  
Account no. ....

Please add 8% VAT to all items except books

The Byte Shop Ltd  
426-428 Cranbrook Road, Gants Hill,  
Ilford Essex. Tel: (01) 518 1414.

All prices correct at time of going to Press

● Circle No. 102

PRACTICAL COMPUTING February 1979

554 2177

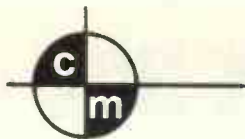

# comart



Comart's Cromemco systems represent probably the widest range of micro computing power available today. Systems are in use in control, research, educational and commercial applications: the S100 standard adds the dimension of future compatibility and expandability.

- \* Single Card Computer
- \* Z80A Z2 Computer
- \* Mini & Standard Floppy Disks
- \* PROM & 4MHz RAM cards
- \* Analogue, Digital, VDU & Printer interface cards
- \* BASIC, FORTRAN IV, COBOL & Macro-Assembler languages
- \* Cromemco System Three

Contact us direct or call your nearest dealer.

The Byte Shop, 426/428 Cranbrook Road, Ilford, Essex ((01-554-2177)  
Cambridge Computer Store, 1 Emanuel Street, Cambridge (0223-68155)  
Computerbits Ltd., 41 Vincent Street, Yeovil, Somerset (0935-26522)  
Holdene Ltd., 10 Blenheim Terrace, Woodhouse Lane, Leeds 2 (0532-459459)  
Isher-Woods, 110 Leagrave Road, Luton, Beds (0582-424851)  
Microcomputermart Ltd., 29 Hanging Ditch, Manchester (061-832-2269)  
NewBear Computing Store, Bone Lane, Newbury, Berks (0635-49223)  
Xitan Systems Ltd., 23 Cumberland Place, Southampton (0703-38740)

COMART LTD., PO BOX 2, ST NEOTS, CAMBS PE19 4NY. (0480-215005)

## The great RAM sale

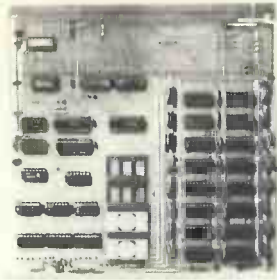

The Nascom system offers major expansion at sale prices. To give you as much choice as possible we offer RAM boards in three configurations to accommodate up to 16 memory ICs of either MK4027 or MK4116, all socketed.

The memory board kit options are:

8K £85.00  
16K £140.00  
32K £200.00

Boards will also accommodate up to four EPROMS of type 2708 at £10.50 plus VAT each. And if you wish to upgrade 16K to 32K it will only cost you an additional £70.

Memory boards plug straight into a NASBUS and an edge connector is included for this. All boards must be used in conjunction with the buffer board which, like the memory boards, is available in kit form ex-stock from approved Nascom distributors.



Nascom Microcomputers

121 High Street,  
Berkhamsted,  
Herts.  
Tel: (04427) 74343

● Circle No. 104

# EQUINOX 300

A powerful multi-user  
multi-tasking  
multi-language

16-bit microcomputer time-sharing system

supporting

- \* BASIC
- \* LISP
- \* PASCAL
- \* Floppy discs
- \* Hard discs

including a powerful Text Formatter,  
Assembly Language Development System  
and disc-based Sort utilities.

Priced from under **£5,000**

Write or phone for further information.

**EQUINOX COMPUTER SYSTEMS LTD**

32-35 Featherstone Street,  
London EC1Y 8QX.  
(Tel: 01-253 3781/9837)

● Circle No. 105

# Euro-Calc Ltd

224 TOTTENHAM COURT ROAD, LONDON W1. TEL: 01-636 8161  
New Shop: 55-56 High Holborn, London WC1 Tel 01-405 3113

**For electronic calculators and watches.**

We have the largest range in London at the most competitive prices.

Export and Personal Export Tax, free facilities arranged.



**HEWLETT PACKARD \* CASIO  
\* SHARP \* TEXAS  
INSTRUMENTS \* OLIVETTI \*  
SEIKO \* SINCLAIR \*  
COMMODORE \* SANYO \*  
NATIONAL PANASONIC, ETC.**

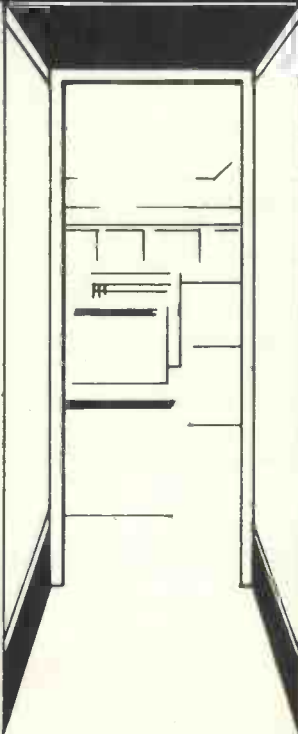

We stock the

**COMMODORE  
PET 2001-8**

**APPLE II**

**NORTH STAR  
HORIZON**

and

**TEXAS SR60a**

microcomputers with a full range of hardware and software options.

● Circle No. 106

PRACTICAL COMPUTING February 1979

# THE BRITISH MICRO



## RAIR BLACK BOX MICROCOMPUTER

- High speed 8085 microprocessor ●
- Priority interrupts and DMA ●
- 64K bytes of RAM memory ●
- Transparent ROM bootstrap loader ●
- Integral dual minifloppy disks ●
- Programmable serial I/O interfaces ●
- Comprehensive range of peripherals ●
- UK wide on-site maintenance ●
- Advanced floppy disk operating system ●
- Serial and random file processing ●
- Macro assembler with symbolic debugging ●
- Extended BASIC interpreter ●
- Relocating FORTRAN IV compiler ●
- ANS 74 COBOL compiler ●
- Quantity and OEM discounts ●
- Leasing and rental facilities ●

RAIR RAIR RAIR RAIR RAIR RAIR

30-32 NEAL STREET COVENT GARDEN LONDON WC2H 9PS TELEPHONE 01-836 4663

● Circle No. 107

## Computer standard

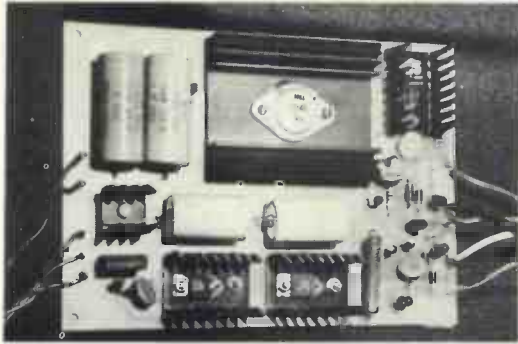

3A PSU

Computers require a reliable and even power supply. The redesigned and uprated Nascom 3A PSU meets these requirements. Its output voltages are +5V 3A; +12V 1A; -12V 1A; -5V 1A. And are sufficient to drive the Nascom-1, buffer board and up to 32K of RAM. It has LED displays on all the outputs and will fit into the Nascom frame to be announced soon. Price of PSU kit—£24.50 plus VAT.

A buffer board kit with edge connectors suitable for the NASBUS and with edge connectors and inter-connectors to attach directly to the Nascom-1 is available at £25.00 plus VAT.



Nascom Microcomputers

121 High Street,  
Berkhamsted,  
Herts.  
Tel: (04427) 74343

● Circle No. 108

# MICRO

The Magazine of the **APPLE**,  
**KIM**, **PET** and other  
**6502 Systems.**

Single issue **£1.50** Subscription **£7.50**  
Overseas Subscription **£8.00**

## How to Order:

In Sterling or U.K. Bank, by Cheque, P.O. or  
Credit Card made payable to:

**L.P. ENTERPRISES**  
Room PC/J  
313 Kingston Road  
Ilford, Essex IG1 1JP, U.K.

Phone: 01-553-1001 for Credit Card order  
(24-hour service)

● Circle No. 109

**NEW LOW  
PRICES**

## 56-STATION ASCII KEYBOARD NOW IN STOCK — ASCII KEYBOARD MODEL KB756

KB756 mounted on PCB

**ONLY £49.50**

(mail order total £55.08)

KB756MF including metal mounting  
frame for extra rigidity,

**ONLY £55.00** (mail order total £61.02)



### SELF-SCAN ALPHANUMERIC PANEL DISPLAY

16/18 position display with 64 character repertoire, 5 x 7 dot matrix. Input 6-bit BCD-code, power requirements +5v, -12v. Character size 0.40" x 0.28". Overall dimensions 8 1/4" x 2 1/4" x 1 1/4". Supplied with full technical data. Price **£55.00 + 75p P&P + 8% VAT** (Mail order total **£60.21**).

#### Optional Extras:

		Mail Order Total
KB15P	Edge Connector	£ 3.25 £ 4.05
KB701	Plastic Enclosure	£12.50 £14.31
KB702	Steel Enclosure	£25.00 £28.62
KB710	Numeric Pad	£ 8.00 £ 9.18
KB2376	Spare ROM Encoder	£12.50 £14.04

## SPECIAL PURCHASE OF SHINSHU SEIKI 21-COLUMN ALPHANUMERIC PRINTER MECHANISMS MODEL AN101F

Continuous rotating drum device with 15VDC motor. 42 character set of alphanumerics and symbols. Printing speed 1.2 lines per sec. on standard 3 1/2" adding machine roll. Supplied with full technical manual. Dimensions: 6" x 4 1/2" x 6 1/2", weight: 3Kg.

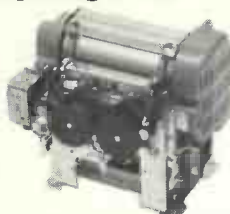

	Mail order total
AN101F Printer	£45.00 £50.76
Amphenol Connector	£ 3.50 £ 3.78

We also specialise in: DEC minis—PDP8 and PDP11 processors, add-on memory, peripherals and spares. Hard copy terminals—ASR 33 and KSR 33 Teletypes, Data Dynamics 390, Texas Silent 700. Send for complete lists.



**ELECTRONIC BROKERS LTD.**  
49-53 Pancras Road, London NW1 2QB.  
Tel: 01-837 7781. Telex: 298694.

Reconditioned

## HAZELTINE VISUAL DISPLAY UNIT

- \* Teletype Compatible
- \* 12" Diagonal Screen
- \* TTY Format Keyboard
- \* 12 lines of 80 characters
- \* 64 ASCII Character Set
- \* 5x7 Dot Matrix
- \* Switch-selectable Transmission Speeds up to 9600 baud
- \* Switch-selectable Parity
- \* Standard CCITT V.24 Interface



**MODEL H-1000 PRICE £350** + carriage and VAT

Also available: —

**Model H-2000:** Buffered/Editing model with direct cursor addressing, dual intensity video, and detachable keyboard with separate numeric and edit clusters. 27 lines of 74 characters. Price **£495.00** + carriage + VAT.

A copy of trading conditions supplied on request

● Circle No. 110

PRACTICAL COMPUTING February 1979



**U.K. DISTRIBUTORS**

Airamco, Ltd.  
Ardrossan, Ayrshire  
Computer Center  
Fleet, Hants.

Computerland, Ltd.  
Gerrards Cross, Bucks.  
Factor One  
Penzance, Cornwall

Leenshire, Ltd.  
Winchester, Hampshire  
Newbear Computing Store  
Newbury, Berks.

Sirton Products  
Coulston, Surrey  
Teleplay  
New Barnet, Herts.

# JADE

## MEM-2 16K Static RAM Board

S-100, fully buffered,  
with PHANTOM and bank  
addressing capabilities,  
can be addressed at 4K  
boundaries.

250ns Kit	\$285.00
450ns Kit	\$250.00
250ns A&T	\$350.00
450ns A&T	\$325.00

## EPROM BOARD KITS

EPM-1 (uses up to 4K of 1702)	\$59.95
JG8/16 (uses 2708 or 2716)	\$69.95

### MICROPROCESSORS

F8	\$16.95
Z80 (2MHz)	\$20.00
Z80A (4MHz)	\$25.00
CDP1802CD	\$17.95
6502	\$11.95
6800	\$16.95
6802	\$25.00
8008-1	\$12.95
8035	\$20.00
8035-8	\$21.00
8080A	\$10.00
8085	\$23.00
TMS9900TL	\$49.95

### 8080A SUPPORT DEVICES

8212	\$2.90
8214	\$4.65
8216	\$2.75
8224 (2MHz)	\$4.50
8224-4 (4MHz)	\$9.95
8226	\$2.75
8228	\$6.40
8238	\$6.40
USRT	
S2350	\$10.95
UARTS	

AY5-1013A	\$5.25
AY5-1014A	\$8.25
TR1602B	\$5.25
TMS6011	\$5.95
IM6403	\$9.00

### BAUD RATE GENERATORS

MC14411	\$10.00
14411 Crystal	\$4.95
6800 PRODUCT	

6810P	\$4.00
6820P	\$6.60
6821P	\$6.60
6828P	\$11.25
6834P	\$16.95
6850P	\$8.65
6852P	\$11.00
6860P	\$9.25
6862P	\$12.00
6871P	\$28.75
6875P	\$8.75
6880P	\$2.50

### KIM SUPPORT DEVICES

6502	\$11.95
6520	\$10.00
6522	\$9.25
6530	\$15.95
6530-002	\$15.95
6530-003	\$15.95
6530-004	\$15.95
6530-005	\$15.95

### CHARACTER GENERATORS

2513 Upper (-12+5)	\$6.75
2513 Lower (-12F5)	\$6.75
2513 Upper (5 volt)	\$9.75
2513 Lower (5 volt)	\$10.95
MCM6571 up scan	\$10.95
MCM6571A down scan	\$10.95
PROMS	

1702A	\$8.00
2708	\$9.95
2716 (5+12) T1	\$25.00
2716 (5v) INTEL	\$60.00
2758 (5v)	\$23.40

DYNAMIC RAMS	
416D/4116 (250ns)	\$12.50
2104/4096	\$4.00
2107B-4	\$3.95
TMS4027/4096 (300ns)	\$4.00

STATIC RAMS	
1-15	16-100
21L02 (450ns)	\$1.50 \$1.20
21L02 (250ns)	\$1.75 \$1.50
2101-1	\$2.95 \$2.60
2111-1	\$3.25 \$3.00
2112-1	\$2.95 \$2.65

FLOPPY DISK CONTROLLERS	
1771B01	\$39.95

KEYBOARD CHIPS	
AY5-2376	\$13.75
AY5-3600	\$13.75
MM5740	\$18.00

## EXPANDOR'S BLACK BOX PRINTER

This 64-character ASCII impact  
printer with 80-column capability  
is portable and uses standard  
8½" paper and regular typewriter  
ribbon. Base, cover and parallel  
interface are included. Assembled  
and complete with manual and  
documentation.



only **\$430.00**  
(90 day manufacturer's warranty)

### TRS-80 Interface Cable for Black Box Printer

with mating connectors: \$48.00  
(must be used with expansion module, +8v/1 amp power  
supply required).

Power Supply for TRS-80/Black Box Printer **\$49.00**

# Look!

## DYNAMIC RAM BOARDS EXPANDABLE TO 64K 32K VERSION • KITS

Uses 4115 (8Kx1, 250ns)  
Dynamic RAM's, can be  
expanded in 8K increments up  
to 32K.

8K	\$199.00
16K	\$255.00
24K	\$310.00
32K	\$369.00

## 64K VERSION • KITS

Uses 4116 (16Kx1, 250ns)  
Dynamic RAM's, can be  
expanded in 16K increments  
up to 64K.

16K	\$292.00
32K	\$432.00
48K	\$578.00
64K	\$721.00

## S-100 MOTHER BOARDS

JADE 6-SLOT	
Kit	\$41.95
Assembled & Tested	\$56.95
Bare Board	\$24.95

## 9-SLOT "LITTLE MOTHER"

Kit	\$85.00
Assembled & Tested	\$99.00
Bare Board	\$35.00

## 13-SLOT "QUIET MOTHER"

Kit	\$95.00
Assm. & Tested	\$110.00
Bare Board	\$40.00

## 22-SLOT "STREAKER"

Assm. & Tested	\$149.00
----------------	----------

# JADE Computer Products

4901 W. ROSECRANS AVENUE  
Department "U"  
HAWTHORNE, CALIF. 90250  
U.S.A.



Discounts available at OEM quantities. All prices above are quoted  
U.S. \$ F.O.B. Hawthorne, Calif., U.S.A. To expedite shipments  
please include international money order or bankers check payable  
against any U.S. bank in U.S. \$, or use your Barclay, Access or  
American Express credit card (include card number, expiration date,  
and signature). Add 20% of total order for postage.

WRITE FOR OUR FREE CATALOG

All prices subject to change without notice.

Telephone:  
(213) 679-3313  
Telex:  
18-1823

## TRS-80 MEMORY EXPANSION KITS

4116's

8 for **\$85.00**  
(16Kx1, 200ns)  
includes dip plugs and  
instructions

★ **TRS-80 Kit** ★  
(16Kx1, 300ns)  
includes connectors and  
instructions  
**\$90.00**

## JADE 8080A

with full documentation

Kit	\$100.00
Assm. & Tested	\$149.95
Bare Board	\$30.00

## JADE Z80

with provisions for ONBOARD  
2708 and POWER ON JUMP

2 MHz	
Kit	\$135.00
Assm. & Tested	\$185.00
4 MHz	
Kit	\$149.95
Assm. & Tested	\$199.95
Bare Board	\$35.00

### JADE

## VIDEO INTERFACE

S-100 Compatible Serial  
Interface with Sockets Included.

Kit	\$117.95
Assm. & Tested	\$159.95
Bare Board with manual	\$35.00

## FLOPPY DISK INTERFACE

JADE FLOPPY DISK (Tarbell  
board)

Kit	\$175.00
Assm. & Tested	\$250.00

S.D. Computer Products  
"Versa Floppy"

Kit	\$159.95
Assm. & Tested	\$189.95

## DISK DRIVES

### MINI DISK DRIVE \$295.00

Model B51 by Micro Peripherals, Inc.  
will operate in either single density  
(125KB, unformatted) or double density  
(250KB, unformatted) modes, up  
to 40 tracks, with a track-to-track  
access time of only 5ms.

### SA801R \$495.00

Shugart single-sided 8 in. floppy  
disk drive.

### DM 2700-S \$750.00

Includes SA801R disk drive, 10 in. x  
10 in. x 16 in. cabinet, power supply,  
data cable, fan AC line filter.

## VERBATIM FLOPPY DISKS

### 5¼ in. Minidiskettes

Soft sector, 10-sector,  
or 16-sector  
**\$4.40 each or box of 10  
for \$40.00**

### 8 in. Standard Floppy Disks

Soft Sector  
**\$4.75 each  
10 for \$42.50**

One year, three seminars  
and 12,000 kits later,  
Nascom presents  
**APPLICATIONS**  
**79**

Two one day seminars to be held in  
London in the Spring of 1979.

Day one will be on small business  
applications. Day two will be  
specifically aimed at the personal  
user.

Write for further details now.



Nascom Microcomputers

121 High Street,  
Berkhamsted,  
Herts.  
Tel: (04427) 74343

● Circle No. 112

**KIMI**

**£99 + VAT**

**COMPUTERBITS**

**P.O. BOX 13, YEOVIL,  
SOMERSET  
0935-26522**

● Circle No. 113

**PETALECT**

ELECTRONIC SERVICING LTD.

**WANTED**

Good Homes for Intelligent Pets

THE

**PET 2001 Computer**

£643.52 plus VAT



Illustrated: PET plus optional sound cassette  
deck and printer (prices on application)

**This unbelievably versatile, compact,  
portable and self-contained unit has  
many varied applications and offers  
tremendous benefits in the worlds of**

- **BUSINESS and COMMERCE:**  
Can be used efficiently for Trend Analysis·  
Stock Control · Payroll · Invoicing ·  
Inventory Control, etc.
- **SCIENCE and INDUSTRY:**  
The 'PET' has a comprehensive set of  
scientific functions useful to scientists,  
engineers and industry.
- **EDUCATION:** An ideal tool for  
teaching and it can be used to keep  
records, exam results, attendance  
figures, etc.
- **ENTERTAINMENT:** Games  
including Backgammon, Noughts and  
Crosses, Pontoon, Black Jack and Moon  
Landing  
**Possesses all usual alphanumeric  
PLUS 64 graphic characters for  
plots, artwork, etc., a printer, 2nd  
cassette deck and software  
available AND IN THE NEAR  
FUTURE 'Floppy Disc' data and  
programme storage system.**  
We have six years' experience in  
servicing electronic calculators, mini-  
computers in S.E. England. 24-hour  
service contract available at £69.50 per  
annum. Credit and leasing terms available.  
**For full details and demonstration  
contact Peter Watts . . . Now!**

**STOP PRESS**

See the full Tandy range  
at our new shop in  
Chertsey Road, WOKING

ELECTRONIC SERVICING LTD

(Authorised Commodore Pet and Tandy Dealer) Specialists  
in Electronic Servicing, Programming, Electronic Design  
and Prototype Manufacture

**33 PORTUGAL ROAD, WOKING, SURREY GU21 5JE  
Tel: Woking (04862) 69032/68497/20727**

● Circle No. 114

PRACTICAL COMPUTING February 1979

# IF YOU CAN'T BEAT THEM:-

## VECTOR GRAPHIC INC



VECTOR V18A slot Motherchassis accepts the wide range of Vector S100 cards and makes an ideal base to build a microcomputer system. Computing power is available to perform a wide range of tasks from industrial control to small business.

PR2 12K PROM/RAM card holds a comprehensive monitor program for system testing and configuration. Normal operation is in conjunction with a serial terminal via I/O card. £350

FLASHWRITER, memory mapped VDU with graphics, allows a system to be built without a terminal or I/O card. Specify version EV of monitor program. £160

I/O, Switchable 110 to 9600 baud serial interface plus two 8-bit parallel I/O ports. £150

High resolution graphics interface bit-maps 8K of RAM to 256 x 256 points, or 128 x 128 with 16 level grey-scale. £125

£150

Z80 Processor card	£140	8080 Processor card	£120
8K Static RAM 4MHZ	£140	16K Static RAM 4MHZ	£300
Analogue Interface	£70	Precision analogue interface	£250
Rackmount 18 slot motherboard	£150	Rackmount power supply	£90

8K Computer System £895

## MICROPOLIS



Micropolis disk drives employ higher standards of engineering to pack either 143K or 315K bytes per diskette, formatted. Supplied complete with controller card, cables, manual and software they plug directly into the S100 bus, 8080 or Z80.

Extended disc BASIC, mnemonic editor and assembler are provided, to run under the powerful MDOS operating system.

Add-on units are supplied to extend the system to four drives and one drive per system may be powered from the S100 bus.

143K System S100 powered	£439	143K Add-on S100 powered	£279
143K System Mains powered	£499	143K Add-on Mains powered	£339
315K System S100 powered	£649	315K Add-on S100 powered	£349
315K System Mains powered	£699	315K Add-on S100 powered	£399
Twin drive System 630K	£1159	Twin drive Add-on 630K	£859
S100 bus regulator	£14	Diskettes per five	£24

Unmounted drives available from £225

# JOIN THEM!

## VECTOR MZ



# £2300

Combining the best features of the VECTOR GRAPHIC computer and twin MICROPOLIS 315K byte drives. The Vector MZ produces, in one package a powerhouse of Microcomputer ability.

The VECTOR PROM monitor bootstraps directly to either MDOS, for housekeeping and Assembly language operation, or to BASIC to run high-level user programs. Provision is made to immediately attach a printer, for example one of the extensive range from Centronics sold by Sintrom, enabling use of the powerful printer-related features in the MICROPOLIS Software.

Applications Software for the VECTOR MZ now in preparation will perform a wide variety of business functions; stock control, invoicing, ledger and mailing lists. Further applications exist as a microcomputer development system, and low cost replacement for minicomputer control and instrumentation.

VECTOR MZ configuration includes:

Twin disk 630K minifloppy;  
Full Micropolis disk software.  
Z80 4MHZ 32K processor.  
1 Serial port, 2 Parallel ports.  
12K PROM RAM card with extended monitor.

And will support:

Flashwriter, Graphics interface, Analogue interface  
Additional RAM, additional minifloppy drives.

Centronics Microprinter	£398
Centronics 779	£780
ADM3A VDU	£620



PRICES EXCLUDE VAT  
ALL EQUIPMENT FULLY ASSEMBLED AND TESTED  
OEM AND DEALER ENQUIRIES WELCOME

DEMONSTRATIONS IN OUR SHOWROOM

Sintrom Microshop

14, Arkwright Road,  
Reading, Berks. RG2 0LS  
Tel: Reading (0734) 84322  
TELEX: 847395  
CABLES: SINTROM READING

## Written for the Nascom

Among the programs written to run on the Nascom-1 and available now are:

### ICL Dataskil Letter Editor

This software provides a comprehensive set of data operations. Text can be input, displayed, edited, stored on tape, retrieved and further amended. Control functions include cursor, character, word, line, scrolling, tabbing, tape store and retrieve, text printing. All in less than 2K byte plus workspace for up to almost two full screens. Price on cassette £70 plus VAT.

### TINY BASIC

A 2K BASIC Interpreter in 2x2708 EPROM. Normal commands: 1-32767 MSL/single array/arithmetic constant/<>≤≥ = ≠/strings valid in print/listing description and user manual/additional three level keyboard control/compatible with NASBUG and B.Bug Price £25 Plus VAT.

An extended version of the above is our TINY BASIC PLUS which has all the TINY BASIC functions plus increased operator manipulation in all sub-routines. Price in 3x2708 EPROM £35 plus VAT.

### ZEAP

An editor assembler which runs under NASBUG and provides the powerful advantages of writing programs in Z80 assembly language instead of directly in machine code. Uses less than 3K bytes of memory and is supplied on cassette priced £30 plus VAT.



Nascom Microcomputers

121 High Street,  
Berkhamsted,  
Herts.  
Tel: (04427) 74343

● Circle No. 116

## AIRAMCO LTD — MICROCOMPUTER PRODUCTS

Distributors for JADE, S. D. SALES, MATROX  
All products brand new with full industrial specification

	ASSEMBLED	BARE BOARD
<b>S100 COMPUTER CARDS KIT</b>		
S100 Mother Board Kit 13 slots .....	£82.50	£26.25
Jade 8080A CPU BOARD .....	£122.50	£22.50
Jade Z80 CPU BOARD 2MHz .....	£135.00	£26.25
Jade Z80 CPU BOARD 4MHz .....	£145.00	£26.25
Jade Serial/Parallel I/O BOARD .....	£129.95	£22.50
Jade 2708/2716 EPROM BOARD .....	£82.46	£22.50
(16 x 2708 or 2716) WITH 8 2708s .....	£134.96	£22.50
Problem Solvers 16K STATIC RAM 450nS	£240.00	—
16K STATIC RAM 250nS	£296.00	—
<b>S. D. SALES STARTER SYSTEM</b>		
Single-card computer system based on Z80. Similar in appearance to KIM or D2 kit. 1K RAM PROM programmers, 4-channel counter-timer, cassette interface, provision for S100. ....	£249.95	—
VERSAFLOPPY DISK CONTROLLER (up to 4 drives 5 $\frac{1}{4}$ or 8") .....	£165.00	—
SHUGART 8" Drive 801R .....	£355.00	—
S100 Desk Top Rack .....	£249.00	£125.00
<b>Components</b>		
2708 1024 x 8 EPROM .....	£6.99	4116 16K x 1 DRAM .....
2716 2048 x 8 EPROM .....	£29.90	8 for .....
(intel)		£75.00
TEXTTOOL 24 pin .....		£5.90
ZERO FORCE SKIS .....	£5.60	6821P PIA .....
(equivalent of above) T.I.		£4.50
1702 256 x 8 EPROM .....	£4.85	AY51013 UART .....
2104 4906 x 1 DRAM .....	£3.50	AY51014 UART (5V) .....
8 for .....	£26.00	AY53600 ENCODER .....
21078-4 4096 x 1 DRAM .....	£3.50	8080A CPU .....
8 for .....	£26.00	21L02-1 450nS .....
MK 4118 STATIC RAM 1K x 8 PIN		8 for .....
OUT same as 2708 EPROM .....	£16.50	21L02 250nS .....
8 for .....		8 for .....
Note New Low Prices 16K Memory		£9.60
All Prices EXCLUDE VAT @ 8%.		2112-1 256 x 4 (450) .....
Trade discounts on Quantity		£2.25
Please add £1.00 P&P for S100 items		4044 4K x 1 (450) .....
then add VAT @ 8%.		£7.45
		4045 1K x 4 (450) .....
		£8.25
		For components please add 40 P&P,
		then add VAT @ 8%.
		AIRAMCO LTD
		30 WITCHES LINN
		ARDROSSAN
		AYRSHIRE
		KA22 88R
		TEL. 0294 65530
		TELEX 779808
		Semiconductor prices are always
		changing and the trend is generally
		downwards. So ring for latest up-to-
		date details.

● Circle No. 117



## THERE'S MORE TO LUTON THAN CAMPARI AND THE AIRPORT

There's the Commodore PET, the APPLE II, the North Star Horizon, Processor Technology's Sol, Cromemco's Z2, Z2D and System 3. Together with disc drives and terminals and printers and VDUs and all manner of accessories and books and magazines. Almost everything the Personal Computer lover could wish for. So put away the holiday brochures and come along to —

**i**sher-woods

PERSONAL COMPUTER SYSTEMS

110 Legrave Road - Luton - Tel (0582) 424851 - Just off the M1.

With acknowledgements to David Campari and Luton Airport.

● Circle No. 118

PRACTICAL COMPUTING February 1979

# Britain is a nation of PET lovers

**THE No. 1  
Personal  
Computer  
in the  
U.K.**

**Hobbyist  
Commercial  
Scientist  
Education**

**Affordable  
£695  
inc. VAT**



for the first time  
user and the professional  
check out the PET, the world's  
most popular personal computer

- \* **CAPABLE** - just like a traditional computer.
- \* **UNDERSTANDABLE** - fast, comprehensive and powerful - BASIC is one of the easiest computer languages to learn, understand and use. Machine language accessibility for the professionals.
- \* **PERSONAL** - easily portable and operated - just "plug in" and go. Unique graphics make fascinating displays.
- \* **EXPANDABLE** - built in IEEE-488 output, 8K RAM expandable to 32K, parallel user port 2nd. Cassette interface.
- \* **SERVICEABLE** - easily serviced - only 3p.c. boards all readily accessible.

#### Features of PETS extended BASIC include

Integer, floating point and string variables; A full set of scientific functions, Logical operators, Multi-statement lines. String functions, Left \$, Right \$, Mid \$, Chr \$, Val, Str \$, Peek, Poke, Usr, Sys, to interface to memory and machine language subroutines. Time of day variable.

Future Commodore developments \* FLOPPY DISC \* PRINTER  
\* MEMORY EXPANSION \* MODEM

Extensive software readily available.

Contact your nearest PET dealer, call today for a demonstration

In case of difficulty call **COMMODORE SYSTEMS DIVISION**  
360 Euston Road, London. Tel. 01-388-5702

## AUTHORISED PET COMMODORE DEALERS

**Bristol**  
Sumlock Tabdown Ltd  
0272-26685

**Derby**  
Davidson-Richards (Int) Ltd  
0332-366803

**Durham**  
Dyson Instruments  
0385-66937

**Grimsby**  
Allen Computers  
0472-40568

**Guildford**  
P.P.M.  
0483-37337

**Hemel Hempstead**  
Data Efficiency Ltd  
0442-57137

**Liverpool**  
Dams Office Equipment Ltd  
051-227-3301

**London W.C.2**  
TLC World Trading Ltd  
01-839-3893

**Manchester**  
Cytex (UK) Ltd  
061-832-7604

**Sumlock Electronic  
Services**  
061-228-3507

**Newport**  
G.R. Electronics Ltd  
0633-67426

**Northern Ireland**  
Medical & Scientific  
08462-77533

**Nottingham**  
Betos (Systems) Ltd  
0602-48108

**Reading**  
C.S.E. (Computers)  
0734-61492

**Southampton**  
Business Electronics  
0703-738248

**Southampton**  
Symtec Systems Ltd  
0703-37731

**Thame, Oxon**  
Memec Systems Ltd  
084-421-2149

**Woking**  
Petalect Ltd  
048-62-69032

### Approved Nascom UK Distributors

Nascom-1 available at £197.50 plus VAT from:

Barrow-in-Furness

**Camera Centre**

Tel: 0229-20473

Torquay

**CC Electronics**

Tel: 0803-22699

Egham & Manchester

**Electrovalue**

Tel: 07843-3603

Glenfield, Leicester

**Eley Electronics**

Tel: 0533-871522

London W2

**Henry's Radio**

Tel: 01-723 1008

Oldham, Lancs

**Lock Distribution**

Tel: 061-652 0431

Chesham, Bucks

**Lynx Electronics**

Tel: 02405-75151

Liverpool L2

**Microdigital**

Tel: 051-236 0707

New Barnet, Herts

**Comp Components**

Tel: 01-441 2922

Glasgow

**Strathand**

Tel: 041 552 6731

Bristol

**Target Electronics**

Tel: 0272 421196



Nascom Microcomputers

● Circle No. 120

# TANGERINE

COMPUTER SYSTEMS LIMITED



**"OWING TO  
TREMENDOUS  
DEMAND we are  
able to extend  
the £10 Discount  
offer until March  
12th 1979!"**

The new low cost VDU - Tangerine 1648  
(See page 16, ETI, Oct. '78 for feature details)

#### ORDERING INFORMATION

The normal KIT price is **£139.86**, which includes postage, packing and insurance and VAT @ 8%. HOWEVER, as an introductory gesture we are **discounting this price by £10**, for all orders received postmarked **BEFORE 12th March, 1979**.

If you require further information, send an A4 sized self-addressed envelope. If you wish to purchase a kit please send a cheque or money order made payable to

## TANGERINE COMPUTER SYSTEMS LIMITED

RIVERMILL LODGE, LONDON ROAD, ST. IVES,  
CAMBS. PE17 4BR

Tel. St. Ives (0480) 65666

# MATROX FROM SHELTON

			PRICE (1 off)
1.	ALT-256**2E	256 x 256 S100 graphics card	£284.00
2.	ALT-2480E	24 lines of 80 characters S100	£213.00
3.	MTX-816	Big characters 8 rows 16 characters per line	£128.00
4.	MTX-1632	Very clear characters 32 characters 16 lines (SL version can be synchronised to TV picture)	£162.00
5.	MTX-A1/MTX-B1	Keyboard scanners and LED driver Single chips direct connection to any CPU bus	£28.00

## SHELTON INSTRUMENTS LTD.,

22/24 Copenhagen Street, London N1 0JD Tel: 01-278 6273

● Circle No. 121

PRACTICAL COMPUTING February 1979

# L.P. ENTERPRISES

Room PC/Ja  
313 Kingston Road, Ilford,  
Essex, IG1 1PJ, England

From Adam Osborne Associates	
INTRODUCTION TO MICROCOMPUTERS	
Volume 0: The Beginners Book	£ 5.95
Volume 1: Basic Concepts	£ 6.30
Volume 2: Some Real Microprocessors (without binder)	£18.95
Volume 3: Some Real Support Devices (without binder)	£11.95
Updating Subscriptions for Vol 2 and 3	£18.95 each
Updating Subscriptions for Vol 2. and 3	£30.00 together
Single issue of updating Subscription	£ 4.00
Binder (specify for Vol 2 or 3)	£ 5.75
6800 Programming for Logic Design	£ 6.30
8080 Programming for Logic Design	£ 6.30
Z80 Programming for Logic Design	£ 6.30
8080A/8085 Assembly Language Programming	£ 6.45
6800 Assembler Language Programming	£ 6.45
Some Common BASIC Programs	£ 6.30
General Ledger (Available from late summer 1978)	£10.95
Payroll with Costing Accounting	£10.95
Accounts Payable & Accounts Receivable	£10.95

From Basic Software Library (from Scientific Research Instruments)	
Vol 1: Business and Games Programs	£17.50
Vol 2: Maths, Engineering and Statistical Programs	£17.50
Vol 3: Advanced Business Programs	£26.95
Vol 4: General Purpose Programs	£ 7.95
Vol 5: Experimenters Programs (General Purpose)	£ 7.95
Vol 6: Miniature Business Systems	£32.50
Vol 7: Chess/Medbl/WDPROC	£26.95

Your Home Computer	£ 7.95
How to Profit From Your Personal Computer	£ 5.50
Hobby Computers Are Here	£ 3.95
New Hobby Computers	£ 3.95

TV Typewriter Cookbook by Don Lancaster	£ 7.50
TTL Cookbook	£ 7.50
CMOS Cookbook	£ 7.95
IC Timer Cookbook	£ 7.50
IC OP-AMP Cookbook	£ 9.50
RTL Cookbook	£ 4.25
Z80 Microprocessor Handbook	£ 7.50
Z80 Instruction Handbook	£ 3.50

Magazines: Back Issues	
Personal Computing	£ 1.75
Interface Age	£ 2.25
Dr. Dobbs Journal	£ 1.75
Computer Music Journal	£ 2.50
Peoples Computers	£ 1.75
BYTE	£ 2.25
Creative Computing	£ 1.75
Calculators & Computers	£ 1.75
ROM	£ 1.75
Kilobaud	£ 2.25
73	£ 2.25
MICRO-6502 Journal	£ 1.50

From BYTE Publications Inc.	
Paperbytes:	
Tiny Assembler for 6800 Systems	£ 5.75
Bar Code Loader for 6800, 8080, Z80 & 6502 Micros	£ 1.75
Best of BYTE Volume 1	£ 8.95

From Scelbi Computer Consulting Inc.	
6800 Software Gourmet Guide & Cookbook	£ 7.95
8080 Software Gourmet Guide & Cookbook	£ 7.95
8080 Programmers Pocket Guide	£ 2.25
8080 Hex Code Card	£ 2.25
8080 Octal Code Card	£ 2.25
8080 Guide and One 8080 Code Card	£ 4.20
8080 Guide and Both Code Cards	£ 6.00
Understanding Microcomputers & Small Computer Systems	£ 7.95
SCELBI 'BYTE' Primer	£ 9.95
8080 Standard Monitor (In Book Format)	£ 9.95
8080 Standard Assembler (In Book Format)	£15.95
8080 Standard Editor (In Book Format)	£ 9.95
8080 Galaxy Game	£ 7.95
Special Package: 8080 Assembler, Editor, Monitor	£20.00

Best of Micro	£ 5.50
Best of Creative Computing Volume 1	£ 6.95
Best of Creative Computing Volume 2	£ 6.95
BASIC Computer Games	£ 5.50
The Colossal Computer Cartoon Book	£ 3.95
Computer-Rage (A Board Game)	£ 6.95
Artist and Computer	£ 3.95

Sybox: Introduction to Personal & Business Computing	£ 4.95
Sybox: Microprocessors from Chips to Systems by R. Zacs	£ 7.95
Sybox: Microprocessors Interfacing Techniques by R. Zacs	£ 7.95
Getting involved with your Own Computer	£ 4.75
Best of MICRO	£ 6.95

Basic BASIC	£ 6.50
Advanced BASIC	£ 6.00
Instant BASIC by Jerald R. Brown	£ 7.95
Your Home Computer by James White	£ 7.95
My Computer Like Me... When I speak	£ 2.75
BASIC by Bob Albrecht	
Games with a Pocket Calculator by Thaigarajan & Stilovitch	£ 1.75
Games, Tricks and Puzzles for a Hand Calculator by W. Judd	£ 2.49
A Practical Introduction to PASCAL	POA

From Peoples Computer Company	
Reference Books of Personal & Home Computing	£ 4.95
What to Do After You Hit Return	£ 8.95
Dr. Dobbs Journal Volume 1	£10.00

Subscriptions start within 3 weeks.	U.K. PRICE	OVERSEAS PRICE
MAGAZINES: Subscriptions		
Personal Computing (Twelve Issues Yearly)	£16.00	£17.00
Interface Age (Twelve Issues Yearly)	£20.00	£20.50
Dr Dobbs Journal (Ten Issues Yearly)	£13.00	£13.50
Computer Music Journal (Four Issues Yearly)	£ 8.50	£ 9.00
Peoples Computers (Six Issues Yearly)	£ 8.00	£ 8.50
Kilobaud (Twelve Issues Yearly)	£20.00	£21.00
Creative Computing (Twelve Issues Yearly)	£16.00	£16.50
Calculators & Computers (Seven Issues Yearly)	£10.00	£10.50
73 (Twelve Issues Yearly)	£20.00	£21.00
BYTE (12 Issues Yearly)	£21.00	£21.00
MICRO-6502 Journal	£ 7.50	£ 8.50
Magazine Storage box (holds 12 minimum)	£ 1.25	

## HOW TO ORDER

Please note our prices include postage and packing, but not insurance, if wanted add 12p for every £10 of books ordered. Make cheques, PO's etc. payable to:-

**L.P. Enterprises.**  
CREDIT CARDS accepted  
BARCLAYCARD VISA/ACCESS  
DINERS CLUB/AMERICAN EXPRESS

Phone: 01-553 1001 for Credit Card orders (24-hour service)

Send to address above  
Indicate Payment Method: All Orders must be Prepaid  
Total Enclosed £.....

..... My cheque, P.O., I.M.O. is enclosed in **Sterling on U.K. Bank**

..... Charge to Barclaycard/Visa/Access/Diners/American Express

Credit Card No ..... Expiry Date .....

Name .....

Address .....

..... POSTCODE .....

Signature .....

All publications are published in U.S.A. and shipped air-freight by **L. P. Enterprises**. In unusual cases, processing may exceed 30 days.

**TRADE ENQUIRIES WELCOME**

● Circle No. 122

# PET SOFTWARE

Of all the microcomputer systems now available, the Commodore PET is the one best supported by software.

The widest range of programs is offered by one company—PESOFT.

You will find a hundred programs in the new 12-page catalogue, covering Business applications, Programming Aids, and some superb Games. Here are just a few examples:

**VAT** £17.50 A package for small businesses. Consultancy Service available.

**PAYROLL** £25 A four program package providing an easy method of pay computation and access to month-end and year end data. Update service available.

**STOCK CONTROL 4** £12 Stores data on up to 150 items per tape file for rapid recall and amendment.

**PERCENTAGE COSTING** £49.50 A powerful method of handling cost information, facilitating the study of percentage changes in total due to individual changes.

**MICROCHESS** £14 Play against the latest version of our famous chess program. Excellent graphics.

**ASSEMBLER/EDITOR** £25 Translates assembly language programs into machine code for direct execution.

**DATA FILE HANDLER** £12 Provides a working file handling structure to be used when writing your own programs.

**MICRO TEXT EDITOR** £15 Line oriented text editor for word processing applications etc.

**BRIDGE CHALLENGER** £10 You and dummy play four person Contract Bridge against the computer.

**PET BASIC TUTORIAL** £15 Let your PET teach you to program in Basic with our best-selling tutorial suite.

**PET WORKBOOKS** £15 Set of five professionally written workbooks covering all aspects of the PET.

For further details of these and the other ninety programs in our free catalogue, call or write to us today.

We also accept credit card orders over the telephone.

## Petsoft

MICROCOMPUTER SOFTWARE  
PO Box 9, Newbury, Berks. RG13 1PB  
Tel. 0635-201131 01-352 1100 Telex 8951672

PET is the trademark of Commodore

● Circle No. 123



## THE TOTAL SOLUTION FROM ALMARC

OF COURSE!

Now Almarc & Vector Graphic offer the complete solution to your computing needs for £2300.00\* . . . The Vector MZ needs only the addition of a V.D.U. and it's ready to go. Completely assembled and fully tested the Vector MZ Offers the following features as standard:-

- \* S-100 bus
- \* 4 MHz Z80A processor
- \* 158 instructions
- \* two quad density Micropolis floppies—over 630k bytes on line
- \* serial port
- \* two parallel ports
- \* 32K static ram
- \* 12K prom/ram board with extended monitor
- \* Extended disc Basic

Simply connect your peripherals (Elbit V.D.U.s & Centronics printers are available from Almarc) and your up and running and, because the MZ uses the S-100 bus, you can plug in a massive range of add on units.

Ring or Write for a demonstration to:-

Almarc Data Systems Ltd.,  
29 Chesterfield Drive,  
Burton Joyce,  
Nottingham.

Tel: 0602 248565.

\* Discount terms available.

● Circle No. 124

## TRS-80

### HARDWARE - SOFTWARE - MODIFICATIONS

If it's new. Hardware, Software, Plug-in Units or Information:- We are importing, selling, writing or manufacturing it for the TRS-80.

### OUR SPECIALITY — WORD PROCESSING

If you are into writing and you haven't written with the TRS-80 Electric Pencil, you haven't lived! The package includes lower-case and the RS232 + 20ma interface.

S100 Motherboards, Digitiser Kits, Plug-in Joy-sticks, 16K Memory Kits and a wide range of American Software. We are the European distributors for the TRS-80 COMPUTING newspaper. Phone or SAE for information or Software list.

## OPTRONICS

1 Strawberry Vale, Twickenham. Middlesex.  
Telephone: 01-892-8455

● Circle No. 125



# THE EXPANDABLE GENERAL-PURPOSE MICROCOMPUTER



## THE RESEARCH MACHINES 380Z A unique tool for research and education

Microcomputers are extremely good value. The outright purchase price of a 380Z installation with dual mini floppy disk drives, digital I/O and a real-time clock, is about the same as the annual maintenance cost of a typical laboratory minicomputer. It is worth thinking about!

The RESEARCH MACHINES 380Z is an excellent microcomputer for on-line data logging and control. In university departments in general, it is also a very attractive alternative to a central mainframe. Having your own 380Z means an end to fighting the central operating system, immediate feedback of program bugs, no more queueing and a virtually unlimited computing budget. You can program in interactive BASIC or run very large programs using your unique Text Editor with a 380Z FORTRAN Compiler. If you already have a minicomputer, you can use your 380Z with a floppy disk system for data capture.

What about Schools and Colleges? You can purchase a 380Z for your Computer Science or Computer Studies department at about the same cost as a terminal. A 380Z has a performance equal to many minicomputers and is ideal for teaching BASIC and Cesisil. For A Level machine language instruction, the 380Z has the best software front panel of any computer. This enables a teacher to single-step through programs and observe the effects on registers and memory, using a single keystroke.

### WHAT OTHER FEATURES SET THE 380Z APART?

The 380Z with its professional keyboard is robust, hardware equipment that will endure continual handling for years. It has an integral VDU interface—just plug a black and white television into the system in order to provide a display unit—you do not need to buy a separate terminal. The integral VDU interface gives you upper and lower case characters and low resolution graphics. Text and graphics can be mixed *anywhere* on the screen. The 380Z also has an integral cassette interface, software and hardware, which uses *named* cassette

files for both program and data storage. This means that it is easy to store more than one program per cassette.

Owners of a 380Z microcomputer can upgrade their system to include floppy (standard or mini) disk storage and take full advantage of a unique occurrence in the history of computing—the CP/MTM\* industry standard disk operating system. The 380Z uses an 8080 family microprocessor—the Z80—and this has enabled us to use CP/M. This means that the 380Z user has access to a growing body of CP/M base-software, supplied from any independent sources.

380Z mini floppy disk systems are available with the drives mounted in the computer case itself, presenting a compact and tidy installation. The FDS-2 standard floppy disk system uses double-sided disk drives, providing 1 Megabyte of on-line storage.

Versions of BASIC are available with the 380Z which automatically provide controlled cassette data files, allow programs to be loaded from paper tape, mark sense card readers or from a mainframe. A disk BASIC is also available with serial and random access to disk files. Most BASICs are available in erasable ROM which will allow for periodic updating.

If you already have a teletype, the 380Z can use this for hard copy or for paper tape input. Alternatively, you can purchase a low cost 380Z compatible printer for under £300, or choose from a range of higher performance printers.

\*CP/MTM Registered trademark Digital Research.

**380Z/16K System with Keyboard £965.00**

**380Z/56K complete with DUAL FULL FLOPPY DISK SYSTEM FDS-Z £3,266.00**

380Z Computer Systems are distributed by RESEARCH MACHINES, P.O. Box 75, Chapel Street, Oxford. Telephone: OXFORD (0865) 49792. Please send for the 380Z information Leaflet. Prices do not include VAT @ 8% or Carriage.

● Circle No. 126

# This Is The Famous

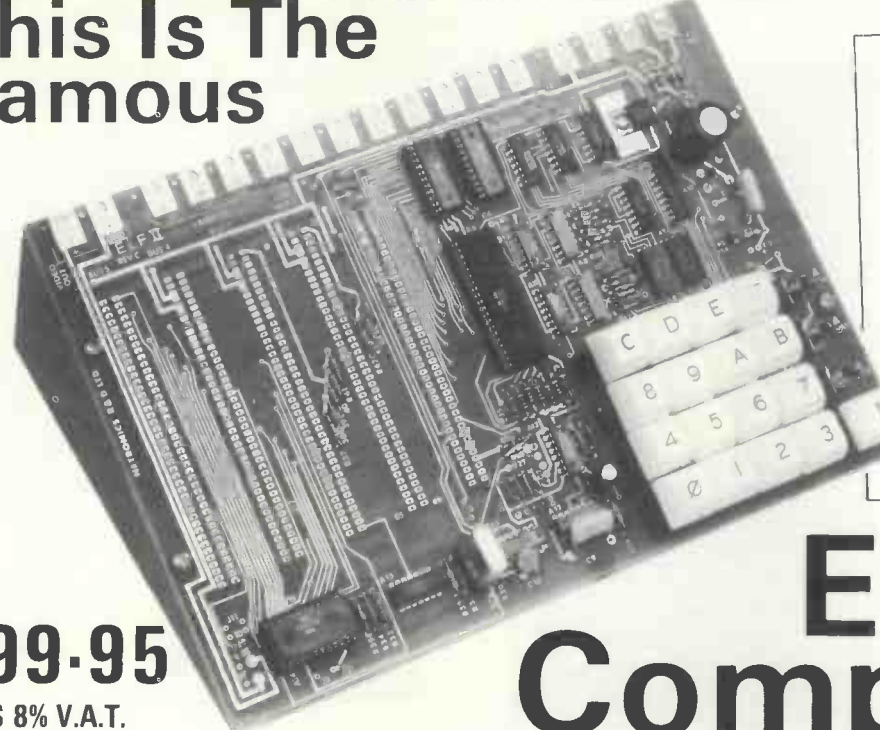

## SPECIFICATIONS

The £99.95 ELF II computer features an RCA COSMAC COS/MOS 1802 8-bit microprocessor addressable to 64K bytes with DMA, interrupt, 16 registers, ALU, 256 byte RAM expandable to 64K bytes, professional hex keyboard fully decoded so there's no need to waste memory with keyboard scanning circuits, built-in power regulator, 5 slot plug-in expansion bus (less connectors), stable crystal clock for timing purposes and a double-sided, plated-through pc board plus RCA 1861 video IC to display any segment of memory on a video monitor or TV screen along with all the logic and support circuitry you need to learn every one of the RCA 1802's capabilities.

# £99.95

PLUS 8% V.A.T.

# ELF II Computer

Stop reading about computers and get your hands on one! With ELF II and our new *Short Course* by Tom Pittman, you can master computers in no time at all! ELF II demonstrates all 91 commands an RCA 1802 can execute and the *Short Course* quickly teaches you how to use each of the 1802's capabilities.

ELF II's video output lets you display an alphanumeric readout or graphics on any TV screen or video monitor and enjoy the latest video games.

But that's not all. Once you've mastered computer fundamentals, ELF II can give you POWER with add-ons that are among the most advanced found anywhere. American IEEE chapters plus hundreds of universities and major corporations have chosen the ELF II to introduce their students and personnel to microprocessor computing!

### Learn The Skill That May Soon Be Far More Important Than Your College Degree!

The ability to use a computer may soon be more important to your earning power than a college degree. Without a knowledge of computers, you are always at the mercy of others when it comes to solving highly complex business, engineering, industrial and scientific problems. People who understand computers can command MONEY and to get in on the action, you must learn computers. Otherwise you'll be left behind.

### ELF II Is The F-A-S-T Way to Learn Computer Fundamentals!

Regardless of how minimal your computer background is now, you can learn to programme a computer in almost no time at all. That's because Netronics has developed a special *Short Course on Microprocessor And Computer Programming* in non-technical language that leads you through every one of the RCA COSMAC 1802's capabilities so you'll understand everything ELF II can do... and how to get ELF II to do it!

All 91 commands that an 1802 can execute are explained to you, step-by-step. The text, written for Netronics by Tom Pittman, is a tremendous advance over every other programming book in print.

Keyed specifically to the ELF II, it's loaded with "hands on" illustrations. When you're finished, ELF II and the 1802 will no longer hold any mysteries for you.

In fact, not only will you be able to use a personal computer creatively, you'll also be able to understand computing articles in the technical press.

If you work with large computers, ELF II and our *Short Course* will help you to understand what makes them tick.

### A Dynamite Package For Just £99.95 Plus 8% V.A.T.!

With ELF II, you learn to use machine language — the fundamental language of all computers. Higher level languages such as FORTRAN and BASIC must be translated into machine language before a computer can understand them. With ELF II you build a solid foundation in computers so you'll really know what you're doing, no matter how complicated things get. Video output also makes ELF II unique among computers selling such a low price. Attached to your TV set, ELF II becomes a fabulous home entertainment centre. It's capable of providing endless hours of fun for both adults and children of all ages! ELF II can create graphics, alphanumeric displays and fantastic video games.

Only a low cost RF modulator is required to connect ELF II to your TV's aerial socket! (To order see below.)

ELF II's 5-card expansion bus (connectors not included) allows you to expand ELF II as your needs for power grows. If you're an engineer or hobbyist, you can also use ELF II as a counter, alarm, lock, thermostat, timer, or for countless other applications.

### ELF II Explodes Into A Giant!

Thanks to ongoing work by RCA and Netronics, ELF II add-ons are among the most advanced anywhere. Plug in the GIANT BOARD and you can record and play back programmes, edit and debug programmes, communicate with remote devices and make things happen in the outside world. Add Kluge Board to get ELF II to solve special problems such as operating a more complex alarm system or controlling a printing press. Add 4k RAM board and you can write longer programmes, store more information and solve more sophisticated problems.

Expanded, ELF II is perfect for engineering, business, industrial, scientific and personal finance and tax applications. No other small computer anywhere near ELF II's low price is backed by such an extensive research and development programme.

The ELF-BUG Monitor is an extremely recent breakthrough that lets you debug programmes with lightning speed because the key to debugging is to know what's inside the registers of the microprocessor and, instead of single stepping through your programme, the ELF-BUG Monitor, utilising break points, lets you display the entire contents of the registers on your TV screen at any point in your programme. You find out immediately what's going on and can make any necessary changes. Programming is further simplified by displaying 24 bytes of RAM with full address, blinking cursor and auto scrolling. A must for serious programmers!

Netronics will soon be introducing the ELF II Colour Graphics & Music System — more breakthroughs that ELF II owners will be the first to enjoy!

### Now BASIC Makes Programming ELF II Even Easier!

Like all computers, ELF II understands only "machine language" — the language computers use to talk to each other. But, to make life easier for you, we've developed an ELF II Tiny BASIC. It talks to ELF II in machine language for you so that you can programme ELF II with simple words that can be typed out on a keyboard such as PRINT, RUN and LOAD.

### "Ask Not What Your Computer Can Do... But What Can It Do For YOU!"

Don't be trapped into buying a dinosaur simply because you can afford it and it's big. ELF II is more useful and more fun than "big name" computers that cost a lot more money.

With ELF II, you learn to write and run your own programmes. You're never reduced to being a mere keypunch operator, working blindly with someone else's predeveloped software.

No matter what your speciality is, owning a computer which you really know how to use is sure to make you a leader. ELF II is the fastest way there is to get into computers. Order from the coupon below!

## H.L. AUDIO LTD., Dept. P.C., 138 Kingsland Road, London E2 8DY

— SEND TODAY! —

### NOW AVAILABLE FOR ELF II —

- Tom Pittman's *Short Course On Microprocessor & Computer Programming* teaches you just about everything there is to know about ELF II or any RCA 1802 computer. Written in non-technical language, it's a learning breakthrough for engineers and laymen alike. £5.00\* post paid!
- Deluxe metal cabinet with plexiglas dust cover for ELF II. £29.95\* plus £1.50 p&p.
- RF Modulator for use with TV set. £3.00\* post paid.
- GIANT BOARD kit with cassette I/O, RS 232-C/TTY I/O, 8-bit P I/O, decoders for 14 separate I/O instructions and a system monitor/editor. £39.95\* plus £1.00 p&p.
- Kluge (Prototype) Board accepts up to 36 IC's. £17.00 plus 50p. p&p.
- 4k Static RAM kit. Addressable to any 4k page to 64k. £89.95\* plus 50p. p&p.
- Gold plated 86-pin connectors (one required for each plug-in board). £5.70\* post paid.
- Professional ASCII Keyboard kit with 128 ASCII upper/lower case set, 96 printable characters, onboard regulator, parity, logic selection and choice of 4 handshaking signals to mate with almost any computer. £64.95\* post paid.
- Deluxe metal cabinet for ASCII Keyboard. £19.95\* plus £1.50 p&p.
- ELF II Tiny BASIC on cassette tape. Commands include SAVE, LOAD, ±, x, +, ( ), 26 variables A-Z, LET, IF/THEN, INPUT,

- PRINT, GO TO, GO SUB, RETURN, END, REM, CLEAR, LIST, RUN, PLOT, PEEK, POKE. Comes fully documented and includes alphanumeric generator required to display alphanumeric characters directly on your TV screen without additional hardware. Also plays tick-tack-toe plus a drawing game that uses ELF II's hex keyboard as a joystick, 4k memory required. £14.95\* post paid.
- Tom Pittman's *Short Course on Tiny BASIC* for ELF II. £5.00\* post paid.
- Expansion Power Supply (required when adding 4k RAM). £19.95\* plus £2.00 p&p.
- ELF-BUG Deluxe System Monitor on cassette tape. Allows displaying the contents of all registers on your TV at any point in your programme. Also displays 24 bytes of memory with full addresses, blinking cursor and auto scrolling. A must for the serious programmer! £14.95\* post paid.
- Coming Soon: A-D, D-A Converter, Light Pen, Controller Board, Colour Graphics & Music System... and more!

Call or write for wired prices!

H. L. AUDIO LTD., Dept. P.C.  
138 Kingsland Road, London E2 8DY  
(Tel 01-739 1582)  
Sole European Distributors for Netronics R & D Ltd., U.S.A.

Yes! I want to run programmes at home and have enclosed  £109.56 including postage and V.A.T. for RCA COSMAC ELF II kit.  £5.94 including postage and V.A.T. for power

- supply (required).  £5.95 for RCA 1802 User's Manual.  £5.95 including postage and V.A.T. for *Short Course on Microprocessor Computer Programming*.
- I want mine wired and tested with power supply, RCA 1802 User's Manual and *Short Course* included for just £164.10 including postage and V.A.T.
- I am also enclosing payment (including postage and V.A.T.) for the items checked at the left.

Total Enclosed £ \_\_\_\_\_  
 USE YOUR  ACCESS  BARCLAYCARD  
 Account No. \_\_\_\_\_  
 Signature \_\_\_\_\_ Exp. Date \_\_\_\_\_  
 CREDIT CARD PHONE ORDERS ACCEPTED 01-739 1582  
 Print Name \_\_\_\_\_  
 Address \_\_\_\_\_

DEALER INQUIRIES INVITED

● Circle No. 127

PRACTICAL COMPUTING February 1979

Our Feedback columns offer readers the opportunity of bringing their computing experience and problems to the attention of others, as well as to seek our advice or to make suggestions, which we are always happy to receive. Make sure you use Feedback — it is your chance to keep in touch.

### Seeking three answers

I AM in the initial stages of trying to acquire a personal computer, for serious use rather than game-playing, and need the answers to three questions. I am not sure if they come within the scope of your advice offer:

Where can I find information about what facilities the CP/M operating system offers? CP/M seems to be much referred to as a "good thing" but no-one gives details.

I will need eventually more than 64K bytes of store; if bank switching is used, can parts of store belong to more than one bank? Or if not, how does one communicate from bank to bank?

Using some form of assembler, rather than Basic, are there any figures available for how well the Z80, 6800 and 6500 make use of program store? This will be a major cost item and should be used efficiently.

W. Stones  
Wokingham, Berkshire

● CP/M really is a good thing. It is from a U.S. software house, Microsoft, which sells it to equipment vendors. You could probably try some of them e.g., Rair (tel. no. 01-836 4663) who have it on their Black Box, or Micro Focus (01-727 5814) which has Cobol running under CP/M. There is also an embryonic CP/M Users' Group being run by our *Computabits* Editor, Nick Hampshire. If you want more information write to him, care of us.

Sadly we do not understand what you mean by "bank switching". Presumably you are looking for a way to address more than 64KB with an 8-bit micro, in which case we do not know of any which can do it simply.

We cannot help you on your use-of-memory question, either.

### Schools should be critical

CONCERNING your review of the 380Z micro in the December issue. For a system which claims to be suitable for education use, several important points were omitted. It surely must be admitted that a single-user system is inadequate for a class of, say, 20 O level students, so should we not be concerned with the multi-user system?

In particular, does it allow data files, multi-user assembler language, and what size of program can be used by eight users simultaneously? It seems reasonable to the CSE student that if programs can be listed on the printer, then so can results. Is this the case?

As one involved in computer education,

it seems to me that schools should be rather more critical of micro systems, and expect the standards of software available on the mini systems of five years ago.

I hope that the "wet blanket" nature of my letter will not affect its printing in an excellent magazine. Surely we must have pros and cons.

M. Parr  
Wombwell, Barnsley,  
S. Yorkshire

### Versatile mailing list

RE mailing programs, page 17 of the December, 1978 issue. We run an SWTPC M6800 with 24K RAM and a MSI FD8 disc system. We have a mailing list of 1,000 addresses, each of which is in one of 15 categories of priority and of 12 separate geographical locations.

The program is run for a Model ASR43 printer with gummed labels. A sample run shows the versatility we have been able to build in. It is possible to select labels for any one or more of the categories in any of the regions or all.

For anyone interested we would be pleased to give further details.

S. J. Chatfield  
Camborne, Cornwall

### Calling users of PDP-11

I SHOULD be much obliged if, through *Practical Computing*, you could make it known that I am trying to start a PDP/LSI-11 users' group. Despite some publicity already, there is still only little support for the group. What I am trying to do is to form a basis for interchange of ideas, expertise and even software for PDP-11 users.

I would be interested to hear from anyone who uses a PDP-11 of any configuration, running under any operating system for any application. Since Digital tells us that it has sold 50,000 PDP-11s so far, there must be many people interested, and hopefully many of them read your magazine.

P. C. Harris  
119 Carpenter Way  
Potters Bar, Herts.

### Do you want to be an author?

WE are a small but expanding publisher of technical text books. Our main interest is to publish a series of books related to computer applications the first being our *Computer Programs That Work*

by Lee, Beech and Lee. This sold out after only eight months with the pleasant result that it is now being re-printed.

There is clearly a market for books such as this, based heavily on program listings with short descriptions. As our first book was orientated towards science and games, we are now interested in the non-science areas of business, information, linguistics and the like.

Other than that, our only requirement is that popular programming languages such as Basic in a widely-used dialect are used by our authors.

If your readers would like to share in our success, perhaps they could write to me with details of their ideas.

D. G. Beech  
Sigma Technical Press  
23 Dippons Mill Close  
Tettenhall  
Wolverhampton

### Services on offer

CONGRATULATIONS on an excellent magazine. I note that in both the November and December Feedback columns, there have been readers enquiring for mailing programs. My company can offer comprehensive mailing services which are used widely by auctioneers, art dealers, trade unions, mailing houses and trade associations.

D. M. Taylor  
North Lincolnshire  
Data Services Ltd.  
Rothwell  
Lincoln

### Where are those discounts?

CONGRATULATIONS on a superb magazine; it is very informative. Your article on computing in schools is an illustration of what my friend and I would like to happen to our school, Liskeard Comprehensive. I want to make my career in computing—both hardware and software interests me—but I have no way of getting hands-on experience with a computer.

My friend and I approached the headmaster, who said a computer would probably be purchased by the school in about two years' time.

In two years time I will be at college. I realise the great potential of a computer at school, but I and others cannot make the school appreciate the point. The options form for lessons which I received at the

(continued on page 21)

## £1 a day keeps your Apple in play

Over a 5-year period our lease/purchase rates are as follows:

**16K machine will cost you  
£25.47 per month**

**32K machine will cost you  
£30.13 per month**

**48K machine will cost you  
£33.69 per month**

At the end of this time you will own the machine

Send for details

**PADMEDE COMPUTER SERVICES**  
The Tuns, High Street, Odiham,  
Nr Basingstoke, Hants.  
Tel: Odiham (025-671) 2434

● Circle No. 128

# EQUINOX 300

A powerful multi-user  
multi-tasking  
multi-language

16-bit microcomputer time-sharing system

supporting

- \* BASIC
- \* LISP
- \* PASCAL
- \* Floppy discs
- \* Hard discs

including a powerful Text Formatter,  
Assembly Language Development System  
and disc-based Sort utilities.

Priced from **under £5,000**

Write or phone for further information.

**EQUINOX COMPUTER SYSTEMS LTD**

**32-35 Featherstone Street,  
London EC1Y 8QX.  
(Tel: 01-253 3781/9837)**

● Circle No. 129

# A more interesting way to learn



## what is a microprocessor?

If you are considering buying a Microcomputer, Development System, or just want to learn more about this exciting technology, then this short introduction to Microprocessors is for you. Comprising a 72 page book keyed to over two hours of cassette tapes, the many aspects of Microprocessors are explained, including Binary and Hexadecimal counting. Internal structure. Operation. Programming Techniques. Devising a program, etc. . . Learn at your own pace with this valuable addition to your reference library.

To Technical Book Services  
P.O. Box 79  
Maidenhead, Berks SL6 2EG

### ORDER FORM

Please send me . . . . . copy/copies of What is a microprocessor?  
@ £10.75 each inclusive. I enclose remittance £ . . . . .

Name \_\_\_\_\_  
(Print Please)

Address \_\_\_\_\_

Registered office 21, Mincing Lane, London EC1 Registered No 12225

● Circle No. 130

(continued from page 19)

end of the third year had Computer Studies on it; soon the course was cancelled through lack of pupils and they also do not have a computer.

My aim is to try to get the school to purchase a worthwhile piece of equipment at a relatively low cost. For this I need a list of most of the possibilities of a computer in school and also prices and details of educational discounts. Can you help?

R. J. Fiddick  
West Looe  
Cornwall

● You probably will not secure any "educational discounts" from anyone if you are talking about a smallish system. Most of the small computer vendors are selling them hand over fist and do not need the extra business. Discounts may be offered by suppliers of bigger and more expensive micro systems, where the price is likely to be more than £2,000.

On the other hand, £800-£900 will buy a ready-to-go Pet or Tandy; £500 will buy a decent micro kit, plus a keyboard and cassette for use with a TV set.

These are not impossible sums, after all, it is only £10 each from 80 willing parents. If the school has a parent-teacher association, you ought to suggest it. We have heard of school children raising cash for computers by running jumble sales, sponsored walks and dances.

One good ploy we have come across is doing advance deals on business systems software; you approach local shopkeepers and small businesses and promise to write and run some fairly simple programs for them when you get your computer. They pay something in advance, of course.

Typical applications for this would be maintaining customer records, perhaps stock records, mailing lists and simple personalised form letters. For this you might also be able to interest your local education authority, if it has any kind of Business Studies programme.

## Choice for a college

THIS college is considering the purchase of a microprocessor-based computer system. The large range of systems available, however, makes us concerned that we make the right choice. Although not exactly novices in the computer world, we are certainly not experts and we find some difficulty in deciding on a system which will best serve our needs.

The college workload is largely committed to the scientific and commerce fields and any system we purchased would be expected to serve both, and also be of use in the routine data processing associated with college administration.

Since our budget is in the region of £3,000, we cannot hope to satisfy our ultimate aims at once but we would like to purchase a "starter" system which would

be immediately beneficial to the college and capable of future expansion.

Briefly, then, we envisage a final system which could support eight simultaneous users, provide enough computer "power" to enable O and A level computer science courses to be run, and have enough flexibility to run typical commercial applications. Within this framework we have isolated a number of features which we feel are essential for any starter system. Thus:

Memory: As much as we can get for our money—about 32K expandable as the cash arises.

Discs: A floppy disc system.

Tape: Magnetic tape for program and data storage (and to compare disc/tape methods).

Printer: Matrix or line printer for rapid printing.

Languages: Basic, with the option of purchasing Fortran and Cobol compilers at a later date.

The Buyers Guides in your magazine have been of immense use to us and, together with our own investigations, suggest that the following computers could form the nucleus of the system we need:

Cromemco (System 2 and Z2), Horizon, Sol 20/16, Pet, Compelec Altair System 1300\*, Computer Workshop System 2, Rair Black Box\*, Research Machines Limited 380Z\*, SEED MS1 6800, Tandy TRS 80.

Those which seem of particular interest to us have been asterisked. It is at this point that the main problem arises. Since we have no familiarity with any of the companies, we find it difficult to make a choice. Consequently we have turned to Feedback in the hope that your experience and that of your readers can help cut some path through the micro jungle.

Problems such as ours must be common among schools and colleges entering the micro field and we are sure many are examining some of the systems we have mentioned. Your comments and advice would therefore be warmly received.

D. Sheppard  
Department of Science  
Barry College of Further Education  
Barry, South Glamorgan

● We have written to Mr Sheppard with our opinion. Anyone with further ideas or experiences of the machines listed may like to contact him to pass on their experiences.

## Stock control problem

I SEE from Feedback in the November issue that advice on systems is available. Could you, therefore, please advise me on the following?

I am looking for a system which could provide stock control initially for 2,000 items but which could be increased when necessary by the addition of more units—

price around £500-£700, either ready-built or be assembled.

M. Page  
Bushmills  
Co. Antrim

● Do you mean stock control or stock recording? If it is stock control you will find it difficult to implement it on a system in your price range. The two which spring first to mind are the Pet and the Tandy, both of which have some stock control/recording programs developed.

You should really be looking for a system costing around £2,000, many of which you will find listed in our Buyers' Guide. If you think about it, purchasing a £2,000 system would probably cost you about £20 a week, which might well be worthwhile—and it is tax-deductible if you are in business.

Incidentally in next month's issue we shall be examining systems available for stock control.

## Computer courses

CAN YOU please suggest computer courses for two of our staff? The first problem they have to solve is to identify the most suitable computer for our purpose. They would be required to program and service as necessary.

Hodges & Moss Ltd  
Shrewsbury  
Salop

● We don't usually like to recommend courses. Our sister magazine, WHICH COMPUTER? has, however, recently reviewed such a course and was favourably impressed. It was called Buying a Computer and was run by Accountants Weekly Courses, tel 01-402 4503. You might also like to contact the National Computing Centre which offers advice to new purchasers of computers. Tel 061-228 6333.

## Anyone for chess

I AM looking for a computer system for around £200. My main interest is computer chess. Do you know if there are any micros which are helpful in this area. Do you think that for a cheap system a full qwerty keyboard is necessary. I have my eyes on a 6800 but I have also heard of a 6809 system. Can you tell me anything about it?

Robert Davis  
London WC1

● Our Buyers Guide details systems like the Kim, Sym and Nascom all of which are within your price bracket and could be programmed to play chess. There is also the Chess Challenger which is a dedicated chess machine available at many toy shops for around £200. If you could spend a bit more money the Pet and Tandy both have very good chess programs which, we admit, have beaten us. As for the 6089, sadly we don't have much knowledge. Can any readers advise?

# The Age of Affordable Personal Computing Has Finally Arrived

Ohio Scientifics

## Superboard II

Full 8K basic and 4K user RAM  
Built and tested

# £263.84

Plus 8% VAT (includes delivery)

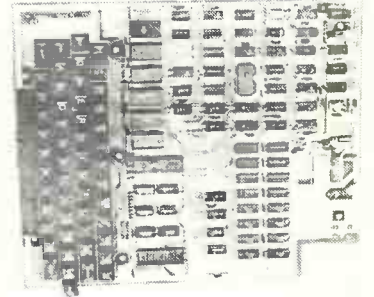

Superboard II was designed specifically with low price and the first-time user in mind. It promises to be the most dramatic price and performance breakthrough to date, in the microcomputer industry. Ohio Scientific, with headquarters in Aurora, Ohio, are one of the leading manufacturers of complete computer systems — from hobbyist right up to business and OEM applications.

The single board construction and custom LSI chips used in the Superboard II result in large cost savings, and ease of use. In fact it has more features and better performance than some other systems that are selling at up to £1,000. In the

early 70's computers with inferior performance cost over £10,000.

The broad range of features include 8K BASIC in ROM, up to 8K of RAM on board (4K supplied), full 53 key computer keyboard, Kansas City cassette interface, video display interface (with graphics). Available options include an expander board for additional 24K RAM, dual mini-floppy interface port adaptor (for printer and modem).

The Superboard II comes preassembled, and only needs a power supply and case. Any 5V supply at 3A will power it.

### Standard Features

- Uses the ultra powerful 6502 microprocessor
- 8K Microsoft BASIC-in-ROM
- Full feature BASIC runs faster than currently available personal computers and all 8080-based business computers.
- 4K static RAM on board expandable to 8K
- Full 53-key keyboard with upper-lower case and user programmability
- Kansas City standard audio cassette interface for high reliability
- Full machine code monitor and I/O utilities in ROM
- Direct access video display has 1K of dedicated memory (besides 4K user memory), features upper case, lower case, graphics and gaming characters for an effective screen resolution of up to 256 by 256 points. Normal TV's with overscan display about 24 rows of 24 characters, without overscan up to 30 x 30 characters.

### Extras

- Available expander board features 24K static RAM (additional mini-floppy interface, port adaptor for printer and modem and OSI 48 line expansion interface.
- Assembler/editor and extended machine code monitor available.

### Commands

CONT LIST NEW NULL RUN

### Statements

CLEAR	DATA	DEF	DIM	END	FOR
GOTO	GOSUB	IF...GOTO	IF...THEN	INPUT	LET
NEXT	ON...GOTO	ON...GOSUB	POKE	PRINT	READ
REM	RESTORE	RETURN	STOP		

### Expressions

#### Operators

—, +, \*, /, ↑, NOT, AND, OR, >, <, <>, >=, <=, =  
RANGE 10<sup>-32</sup> to 10<sup>+32</sup>

### Functions

ABS(X)	ATN(X)	COS(X)	EXP(X)	FRE(X)	INT(X)
LOG(X)	PEEK(I)	POS(I)	RND(X)	SGN(X)	SIN(X)
SPC(I)	SQR(X)	TAB(I)	TAN(X)	USR(I)	

### String Functions

ASC(X\$)	CHR\$(I)	FRE(X\$)	LEFT\$(X\$,I)	LEN(X\$)	MID\$(X\$,I,J)
RIGHT\$(X\$,I)		STR\$(X)		VAL(X\$)	

Plus variables, arrays and good editing facilities

Fully built and tested. Requires only +5V at 3 amps and a videomonitor or TV and RF converter to be up and running.

There is enormous interest in Superboard II, so order early if you wish to avoid inevitably long delivery dates later this year.

### FREE 15-DAY TRIAL

Lotus Sound have had so many questions about various aspects of Superboard II that in order to save time, and ensure your satisfaction, we are offering to return the full purchase price to anyone who returns their machine—in good order and original packing—within 15 days of delivery.

# LOTUS SOUND

4 MORGAN ST., LONDON E3 5AB

Mail order only  
Callers by arrangement

01 - 981 3993 (24 hr answer)  
Telex 261426 Attn: Lotus Sound

To: **LOTUS SOUND**  
4 MORGAN ST., LONDON E3 5AB

Please send me ..... Ohio Scientific Superboard Computer(s)  
I enclose cheque/PO for £ .....

Name .....

Address .....

CT1

● Circle No. 131

PRACTICAL COMPUTING February 1979

## Two word processing systems from Comart

COMART has introduced two new word processing systems, both for the Sol range of microcomputers, which the company imports from the U.S.

Solstar runs on the Sol 20/16 with mini-floppies. Corrections, additions, deletions and movement of characters, words, phrases or blocks are accomplished in a simple, direct manner, with all text copy displayed on the memory-mapped video display for ease and speed of assimilation.

Wordwizzard runs on a Sol 3 with 64K and a Helios dual disc drive. Advanced facilities include the ability to print-out one text while editing a second,

and a special keyboard template permitting operator commands to be implemented with a single key depression.

The Solstar costs £2,500 and the Wordwizzard £5,000, but both need the addition of a printer—the Diablo daisy-wheel is recommended—to complete the system. Both systems have a four-week delivery time.

The Sol microcomputer range has several features which have made it popular in word processing applications in the U.S.

It has a top-quality capacitive keyboard, ensuring reliable keystroke performance over a long period; the video

display is flicker-free without the "ripple-through" effect of some c.r.t.s; and the equipment is designed stylishly to fit into an office or home environment.

The introduction of these systems, together with that of Cobol for Cromemco microcomputers, heralds the Comart entry into the commercial market; previously it has concentrated on scientific, educational and industrial applications.

The Cobol implementation is for Cromemco Z2-D and System 3 microcomputers with at least 48K bytes of memory. It is written to AINSI 1974 standard with all Level One features and the most useful ones of Level Two. It costs £85.

Also connected with the move into the business systems market is the agreement with Computer Field Maintenance to provide a nationwide field service for the Cromemco, North Star, Processor Technology, Dynabyte and Sol microcomputer systems Comart distributes in the U.K.

There will be a standard 48-hour or better response for an estimated cost of 12 percent of Comart list price for the product in question.

Service centres in London and Manchester will be followed by others in Glasgow and Nottingham.

Comart can be contacted for details of all its products and services at PO Box 2, St Neots, Cambridgeshire.

### Cromemco System 3



## Latest Lib is for the calculator user

THERE are genuine fears about machines taking over everything, but it is still a shock to find the machines apparently standing up for themselves.

Calculator Lib is, in fact, the title—probably meant to increase the paranoia of the most neurotic of us—of the newsletter of the Liberated Calculator-users' Club. Set up by Canadian, Gene Hegedus, it is: "a truly universal, independent, non-profit group of calculator users (regardless of the make of the calculator) dedicated to exploring the limits of the state-of-the-art of calculator-mathematics.

The overall goal is to profit

mutually from all members' knowledge of calculators and related fields, and create a forum which allows club members to meet and identify with each other's interest. The club needs volunteer members to act as officers in the editorial committee, correspondents, reporters and translators.

Club members speak or write English, French, German and Hungarian. This list will hopefully be expanded with readers in other countries".

For more information, send large, self-addressed, stamped envelope to Gene Hegedus, PO Box 2151, Oxnard, CA 93034.

## Integral unit

MICROCOMPUTER suppliers probably have more new products to launch than any other section of the industry, so it is not surprising that so many capitalised on the Compec exhibition for initial exposure.

ISG Data Sales of Maidenhead premiered a new development system and terminal from Futuredata Computer Corp of Los Angeles. Advanced Microcomputer Development System (AMDS) provides in one unit a c.p.u., keyboard and c.r.t., claimed to be the first such integral unit.

There is a choice of microprocessor c.p.u.—the 8080, 8085, 8086, 6800, 6802 and Z80 are offered; and a standard 64-key keyboard and 12in. display. Memory is expandable from 16–64K RAM.

A comprehensive set of packages is available for software development, including debug facilities, editors, assemblers and Basic compilers. There are also hardware facilities for debugging and emulation.

The 80-character display comprises 24 lines of 7 x 9 dot matrix with upper- and lower-case characters, enhanced video, reverse video, underlining, highlighting and line graphics.

A basic 16K system costs £8,000 from ISG Data Sales, Moorbridge House, 50-52 Moorbridge Road, Maidenhead, Berkshire.

## Graffiti winners

This month's winning entry is from Andrew White, aged 16, of 19 Greenpark Drive, Co Armagh, N. Ireland.

*The micro in the corner,  
Not used for o'er a week,  
Is moping for a program,  
Just waiting for a little  
PEEK.*

*It's BASIC is getting hazy,  
Through a boring lack of use,  
Computers, too, have  
feelings,  
And don't take kindly to  
abuse.*

*But this eternal waiting,  
On a shelf for weeks on end,  
Is enough to drive a micro,  
To an enemy, from a friend.*

*A customer enters,  
The micro he is shown,  
A demonstration "NOT  
FOR ME"*

*As 'cross the room the  
customer is blown.*

*Take heed, you micro traders,  
Computers aren't just steel,  
Instead, inside that circuitry,  
Is something which can feel.*

The runner-up is G. P. Dixon, of Windlesham.

*Our micro has caught the  
disease,  
Of charging its users large  
fees,*

*It says—"Look here, Gus  
I'm driving this bus,  
Sit down—log in—tickets  
please".*

# 'Most powerful' claim by Intel

THE iSBC 86/12 single-board computer is the most powerful microcomputer board to come to the market so far, claims its manufacturer, Intel.

It has a 5MHz CPU which exceeds the PDP-11/34 in performance and will replace four standard minicomputer boards in a typical OEM system at about half the cost, the company says.

An 8MHz, soon to follow, will increase the gap in performance over mid-range minis even more.

The iSBC 86/12 is a 16-bit CPU, with memory up to 48K bytes, dedicated parallel I/O and serial communications interface all on the same board. It plugs straight into the standard Intel Multibus and can be expanded using any of the wide range of expansion cards available from Intel or the 100 other manufacturers which support the Multibus.

They include RAMS up to

64K bytes, ROMs, up to 64K bytes, battery powered RAM boards, PROM programmer boards, mini and standard disc controllers, hard disc controllers, 3M cartridge controllers, cassette controllers, video graphic boards, analogue I/O boards, keyboard/CRT controller boards, relay output boards, isolated input boards, communication I/O boards, and communications controllers.

The arrival of the iSBC 86/12 reveals the purpose of several lines on the Multibus which were not needed by 8-bit minis. They are an additional eight data lines and four more address lines, increasing the number to 20 to cater for the one megabyte addressing capacity; and a byte control line, which allows both 8-bit and 16-bit CPUs to be used on the same Multibus system.

Employing the 8086 16-bit CPU, the 86/12 has a compre-

hensive instruction set which includes multiply and divide in binary, BCD of ASCII.

Communications are handled by a separate V24 (RS232C) serial port, which will support virtually any communications protocol. Baud rates for this port can be software-selected from 75-9,600 in asynchronous mode, and from 1,760-38,400 in synchronous mode.

Other functions supported are event counting, timing and vectored interrupts—the board supports nine, expandable to 65, levels. The board also incorporates an auxiliary power bus and power failure interrupt control logic for employing battery supply to protect the contents of the read/write memory during a power failure.

Intel Corporation (U.K.) Ltd., 4 Between Towns Road, Cowley, Oxford OX4 3NB.

## Bristol bound

THE Nascom-1 microcomputer system is now being distributed in the Bristol area by Target Electronics, one of the largest suppliers of semiconductors and electronic components in the area. The Nascom system is the only microcomputer the company handles.

Target Electronics, is at 16 Cherry Lane, Bristol BS1 3NG.

## Harlow Z80 spot

HARLOW-BASED distributor DISTRONIC is offering off-the-shelf Z80 microprocessors from Mostek. It also has full development facilities available.

Full software support is provided, with a strong emphasis on high-level languages and a disc-based development system offers advanced real-time debug facilities. The price for quantities of 1-24 is £23.03.

DISTRONIC, 50/51 Burnt Mill, Elizabeth Way, Harlow, Essex.

## CCS Microhire

MICROCOMPUTER  
RENTAL  
SPECIALISTS

**Before you buy a micro, why not hire it for a day or a weekend?**

**From £2 a day we hire out a range of micros for evaluation/experience or program development.**

- \* Apple II
- \* Commodore Pet
- \* Nascom I or Micros
- \* Research Machines 380Z
- \* SWTC 6800 or MSI 6800
- \* Tandy TRS 80

Protect your future investment.  
Try out a system now.

For details write to  
**CCS Microhire, Freepost,  
Letchworth, Herts SG6 4YA**

## Kim 1 for less than £100

COMMODORE has reduced the price of its KIM 1 to £99.95p.

This price puts it well in the range of students, hobbyists and schools, but it remains ideal for control applications and training in industry.

Commodore stresses that the Kim 1 is not a kit, but a complete microcomputer with a fully-assembled PC board, needing only a power supply to operate. Based on the MOS 6502 microprocessor, it has 2K bytes of ROM, 1K byte of RAM, a keyboard and six-digit LED display.

The system can be expanded significantly, starting with the KIM 3 8K RAM memory boards (£193.32p. inc. vat). This can be wired in by the user—all the required connectors are built-in—or attached more neatly by using a KIM 4 motherboard (£96.12 inc. vat).

An ordinary audio cassette unit can be attached to provide auxiliary storage. All inter-

face circuits provided on the KIM 1 board including a Teletype interface, are ready for connection. If the Teletype has the facility, KIM can also handle paper tape input and output.

The range of peripherals for use with the system has been expanded in collaboration with distributors.

Options include a pocket terminal (£240), which allows input of the full ASCII character set from 40 dual-purpose keys; and a videoboard (£150) which allows a normal television to be attached as a video display device.

Kim also boasts excellent documentation of hardware and programming instructions, plus powerful software.

They include an Assembler/Disassembler/Editor package, an information retrieval system, a mailing list program for business use, and a variety of games. The prices of them range upwards from £12.





Near-total paralysis has not prevented Chick Smith developing his interest in computing.

## 100 times faster

TURN your Pet into a small business system. That is what a firm in Solihull is suggesting now that it has attached a mini-floppy disc system to the Pet.

Midland Micronics has bolted two 5¼ in. floppy discs neatly on each side of the VDU. It is engineered very neatly so that it looks part of the machine.

The advantage of using floppy discs is that it is much faster than a tape cassette and you can hold more information. Midland says that each diskette can hold up to 81K bytes of data and is 100 times faster to access than the tape.

Connection of the drives is via the Pet memory expansion board and the system is complete with an additional plug in PROM permitting control of the disc system via Pet Basic USR instruction with simple commands from either the keyboard or under program control.

The floppy disc Pet is in two versions, 24K or 32K, and the starting price is £1,300. More from Midland Micronics, Oakfield House, Station Road, Dorridge, Solihull, W. Mids.

## Micro interest via chess route

CHICK SMITH is a resident of the Thistle Foundation for the severely handicapped in Edinburgh. Near-total paralysis has not prevented him developing his interest in computing.

An Apple II and cassette recorder are mounted on a trolley beside his bed and operated via a specially-designed separate keyboard mounted on a frame over the bed.

Chick operates the keyboard using a perspex rod in his mouth. Control and shift keys have been modified to lock in position. His wife, Beth, changes cassettes when necessary.

A keen chess player, Chick first experienced the delights of micros after buying a Chess Challenger and rapidly discovering its limitations. He has received help in installing the Apple from staff of Edinburgh University and members of the Scottish Amateur Computer Society, but is almost entirely self-taught.

Programs he has written include a number of games programs and a chessboard display. He also has the Apple

voice-response unit for which he is still developing applications.

## Tiny Basic is here

TINY BASIC is not the managing director of a multinational trading empire but a new language for the beginner to microcomputer programming.

Written by the Golden River company the language is designed specifically for a microcomputer with minimal memory. It will accommodate approximately 100 statements in 2K bytes of Ram.

It includes all the basic functions of Basic, including a line editor, an assortment of error messages to the user and a surprising amount of processing capability.

Floating-point arithmetic, arrays, alphanumeric strings and other advanced facilities may be added via a machine language extension.

The ability to expand the language in this fashion makes it suitable for both novice and experienced programmers.

It is supplied resident in a

## Paris in the Spring

LET Compec be a warning to all those in the business of selling or servicing small computers. Exhibitions are subject to the same buoyant demand as the rest of the industry.

In particular, those who could not get space at Compec should already be thinking about Europe Micro/Expo 79, which looks like being the biggest in Europe.

Organised by Sybex Europe, it is scheduled for 15-17 May at the Centre International de Paris and although the size of the exhibition hall has been doubled, 20 percent of the available space had been booked before the first mailing.

An intensive campaign is already underway using direct mail, the technical press and TV—a 45-minute special has already been screened in France—so the show is assured of good attendances.

The majority of visitors will, no doubt, be from France but the campaign is being taken to all major European countries, so there should be substantial number of visitors.

More details can be obtained from Sybex Europe, 313 Rue Lecourbe, F-75015, Paris.

2716 EPROM, or fusible link PROM, ready to install in the Golden River Mk 4 microprocessor system or GRO430 single board computer. It is complete with a manual and costs, with chip, around £100.

Golden River is at Telford Road, Bicester, Oxon.

## Christmas competition

NEXT MONTH we shall reveal who the nine lucky finalists are in our £5,000 Christmas computer competition.

By the closing date on December 31, our offices were absolutely swamped with entries with ideas galore for computer applications.

The nine finalists will then be asked to develop their ideas into a flowchart demonstrating how the system could work. Don't miss next month's issue out February 15.

# MICROCOMPUTER TRAINING

**Minicomputer and Microcomputer  
Systems: Management Assessment**

5 March 1979  
4 June 1979  
1 September 1979  
26 November 1979

**Microprocessors:  
Assessment and Application**

6-8 February 1979  
1-3 May 1979  
4-6 September 1979  
30 October-1 November 1979

**Minicomputer and Microcomputer  
Systems in Industrial Control and  
Automation**

21-23 March 1979  
20-22 June 1979  
17-19 October 1979  
5-7 December 1979

**Microcomputer Programming and Design  
Techniques for Engineers**

19-21 February 1979  
14-16 May 1979  
17-19 September 1979  
12-14 November 1979

**Microcomputers in Commercial DP**

1-2 March 1979  
24-25 May 1979  
27-28 September 1979  
22-23 November 1979

**High Level Languages for Microprocessors**

22-23 February 1979  
17-18 May 1979  
20-21 September 1979  
15-16 November 1979

**Microcomputer Techniques for Computer  
Systems Designers**

26-27 February 1979  
21-22 May 1979  
24-25 September 1979  
19-20 November 1979

**Advanced Microcomputer Design  
Techniques**

28 February-2 March 1979  
23-25 May 1979  
26-28 September 1979  
21-23 November 1979

For further details of these Microcomputer training courses complete the form below.

Please send me information on Microcomputer training

Name \_\_\_\_\_

Job Title \_\_\_\_\_

Organisation \_\_\_\_\_

Address \_\_\_\_\_

Telephone Number \_\_\_\_\_



**Return to:**  
**Infotech International Limited, Nicholson House, Maidenhead,**  
**Berkshire. Telephone 0628 35031, Telex 847319.**

# Business packages

Many business packages are now coming onto the market. This month we look at some systems available for estate agents and for doctors.

HB COMPUTERS in Kettering has developed a package for estate agents for the Pet. The total system at around £710—the software selling for £15—was developed by HB with help from a local estate agent, Parkhouse and Partners.

It is a simple but effective way for estate agents to call broad details of a property on the screen while the potential customer decides immediately whether more information contained on filed broadsheets is required.

Input is typed-in at the end of a day from property detail sheets the agent completes during the day as he views each property. The main breakdown for each property is price; the other kinds of input data include type and location, number of rooms, number of bedrooms, garage, features, and so on.

When an enquiry on a property is received, the data tape of the appropriate price range is read totally into memory—each data tape can hold about 60 properties, depending on detail. As the customer decides his interest in each property, the folio number of each broadsheet in the files is noted and the pulled sheets are sent, or handed, to the potential customer.

HB claims that about 30–60 minutes' training in the estate agent's office, given by HB, is all that is needed to get the system started and running.

HB believes enhancements to the package will provide automatic collation and mailing of property details to customers. It would also like to see an inexpensive printer attached to provide alternative output.

Another estate agents' package is being offered by Compelec, of Berners Street, London, W1 on its Series 1 system for about £7,000, including the software. Bought over three years, it would cost about £60 per week. The package, similar to that used in the Altair 300 estate agents'

system, is more comprehensive in its facilities than the HB package, as its price indicates.

The Altair 300 is a multi-user system but this is a single-user, single-office system using a 64K machine, 1-megabyte floppy, a VDU and Qume printer. Some of its features include:

- Storage of up to 30,000 properties and applicants;
- Ability to match properties with applicants using up to 48 attributes;
- Applicant address labelling;
- Data analysis of stored items—e.g., number of properties notified, effectiveness of advertising, method of approach to the agent;
- Immediate backlog listing—e.g., 50 properties including price, address, office to contact, and brief description of property can be produced in less than four minutes;
- Automatic culling of applicants' list after a pre-set review time;
- Alphabetical listings available at any time;
- Modular system design means that a feature such as accounting or property management can be added later at a reasonable cost.

For doctors, we have uncovered two applications for micros—the Computer Workshop MICKIE and the Compelec Patient Accounting System.

Computer Workshop of Dover Street, London, W1, using software developed by the National Physical Laboratories, produced an application system for doctors called MICKIE—Medical Interviewing Computer.

To be used in five areas of DHSS to start, the systems set up a patient/machine interface where the patient answers questions on the screen using a "button box" with only four buttons. Making certain that the patient is first literate and can read the characters on the screen, the doc-

tor leaves the patient to complete the questionnaire. The information obtained is stored and then printed-out on the MICKIE printer in whatever format suits the doctor.

Patients apparently seem to prefer to talk to the machine because they can take their time answering questions. An interview takes about 40 minutes and its length depends on the illness, the patient's age, and so on.

West Middlesex Hospital is operating MICKIE for patients with abdominal pains and in the future will set up MICKIE for backache complaints. Doctors have praised the system because of the great savings in doctors' and nurses' time.

A different kind of doctors' package is being offered by Compelec, of Berners Street, London, W1. The system, at about £6–7,000—the included software costs about £1,000—is for account management.

The system generates a patient ledger, charges and receipts, new accounts, recall reminder list/labels, aged debt analysis, delinquent reports, practice income statements, and a query function.

Aimed at the single-site, single-user market, the system has at its heart the Compelec Series 1. The number of accounts and patients' data which can be held is dependent on the length of the record needed but the system should accommodate the number of patients within a normal partnership easily—say 1,000 patients.

Compelec expects to enhance the software to include insurance reports, treatment plan estimator, patient charts, appointment book, inventory control, and general ledger.

## Conclusions

- At the micro end of the market the picture is relatively grim for users seeking a very inexpensive system with the application software already written, so praise for these items for at least a start in the right direction.
- There is a great opportunity for bright, innovative software houses to start attacking the industry application market. In the near future we will be looking at druggists' systems, solicitors' packages, client accounting, temporary employment agency systems, management consultants' packages and perhaps publishers. ■

Computer Workshop—developing systems for doctors.





The popularity of Pet and the diversity of ideas from Pet owners is to some extent acting as a focal point for micro-computer users in *Practical Computing*. So we are starting a *Pet Corner* for those who have the Commodore baby—and for those who wish they had.

These pages represent an independent collection of news and views. The principal focus is Mike Lake, of the Independent Pet Users' Group (IPUG): if you wish to contact *Pet Corner*, write to him or send articles/snippets/ideas to us directly.

The idea of a group, completely independent of Commodore, was first conceived by Norman Fox of Welwyn, Herts. He contacted several Pet owners and circulated a newsletter to everyone he knew. The group had its first meeting last October, when members met to discuss what the group could do.

Obviously the most important role for the group is to facilitate communication between Pet owners and users. All over the country there must be users who are re-inventing the wheel over and over again. If the group can provide a forum for the circulation of information and ideas, then it will have been a success.

At the second meeting of the group in November, James Chambers, of the psychology department in London University, allowed us to see some of the ways Pets are used to help in experiments. Pets are the ideal method for teaching students programming, he said, and with the knowledge thus gained new ideas could be tried out.

We saw a Pet being used to operate a variety of experimental equipment; shutters, projectors, and stimulus-response measuring apparatus. The day is with us when the experimenter can set up the Pet, let it control the experiment and then produce all the statistical results without delay.

### What IPUG offers

We hope that as well as regular meetings, IPUG will be producing a regular newsletter for Pet users. Anyone interested should send £2.50 (payable to the group) to the secretary, Mike Lake, at 9 Littleover Lane, Derby.

Thanks to the help of Julian Allason of Petsoft we have been able to circulate most Pet owners with information about the group. You don't have to be a Pet owner to join, though—just contact Mike.

### Hardware: Mike's moans

Why is it that so many items we may wish to interface with Pet are so expensive? To take one or two examples: a TV interface has been offered by one or two companies at £75. My prototype which, incidentally, works well, cost less than £5. Even with all the connectors and switches I put on the final version, it cost only £10. Someone, somewhere is trying to rip us off.

Secondly, what about additional memory? Anyone who has compared the costs of Commodore memory for Pet with

the prices for the Tandy TRS-80 must be feeling sick. I know all about the problems of importing American boards but with an expanding market here, isn't it time someone made a good British-made board at a reasonable price?

*Practical Computing* will be having Plessey's Petite add-on memory for a hands-on test in the next few weeks; watch this space.

Connectors to the outside world from the Pet ports are still hard to obtain. Some are supplied without a cover. Not only is this not aesthetic, it could also create shorting problems. If suppliers of decent connectors will contact us we will print a list.

Now a moan at Commodore. The cassette unit has two irritating problems—it may sometimes partially erase the tapes used for writing on, and head alignment on different machines may be so far out that tapes produced on one Pet cannot be read on another.

These are not major defects to solve and it seems a pity that, after producing such a good machine, Commodore has not been a little more forthcoming on these issues.

A minor but equally irritating point which has been bothering a number of owners is **keytop wear**. If your Pet is used regularly, in a few months it will become impossible to read some of the keys—particularly RETURN and SHIFT. This is because the key label is only stuck on; a well-designed machine then becomes tatty through a relatively trivial problem.

We will print any decent solutions. Please send your suggestions quickly—Mike's keys are just beginning to give problems.

### Simply software

On the subject of PEEK and POKE, try this in the middle of a program:

```
WAIT 59410,4,4
```

When everything goes dead, try pressing STOP. Surprise, surprise—nothing happens. To put yourself out of your misery, press SPACE. All should then be well. This could be a very useful device for preventing anyone stopping an important

program in mid-flight. Perhaps you may be bold enough to try:

```
WAIT 59410,1,1 and WAIT 59410,2,2 and
WAIT 59410,8,8 and WAIT 59410,16,16. I don't
recommend WAIT 59410,32,32.
```

Here is another nice one:

```
POKE 59409,52
```

This will make the screen go dead. Now try:

```
POKE 59409,60
```

and all should reappear.

This is very effective in a program if you set up a screen of information with the screen POKED out, then POKE it in again. An instant screenful will appear.

### Music to our ears

Pet is not an excellent musician but it can play tunes. If you want it to start playing notes then it is very easy. First, connect up the user port like this:

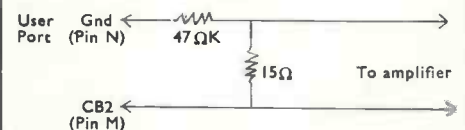

The output can go to a hi-fi or to a simple amplifier feeding headphones (Circuit next month if enough people want one).

Now the magic pokes:

```
POKE 59467,16
POKE 59466,15 (or 51 or 85 try them all)
POKE 59464, any number 1-255
```

You should now hear a tone from the speaker. You can control the length of a note by the use of a loop, or by checking the timer. I will give a full list of notes, frequencies and poke codes next month. You **MUST** POKE 59467,0 after use or your cassette will not work.

### Book bicker

A good deal of reading matter is available for those setting out with Basic, but what about those who wish to take up machine language programming on the Pet? The 6502 software manual is fine, but is written at a fairly advanced level.

(continued on next page)

(continued from previous page)

**Independent information**

**There are four good independent U.S. newsletters for Pet:**

*The Pet Gazette*,  
Microcomputer Resource Centre,  
1929 Northport Drive,  
Room 6,  
Madison Wi 53704  
U.S.A.  
(Free, monthly)

*Cursor*  
P.O. Box 550,  
Goleta,  
California 93017,  
U.S.A.  
(Monthly)

*The Pet Paper*,  
P.O. Box 43,  
Audubon,  
Pa 19407,  
U.S.A.  
(\$2 per copy, monthly)

*Pet Users' Notes*,  
P.O. Box 371,  
Montgomeryville,  
Pa 18936,  
U.S.A.  
(\$10 for six issues per year)

# Is your memory good?

A VITAL component of your processor is the memory. A single faulty bit in a 32 kilobyte system represents an error of only about 0.000381 per cent but can create chaos with your programs, giving complete program failure or, possibly worse, still inaccurate results.

Though the bits which make up each byte are often used in terms of "least significant", "most significant", and the like, a faulty memory cell is just as destructive to performance, whichever bit it represents. Fortunately, because of the nature of a processor, it is not necessary to resort to the use of oscilloscopes and logic probes to check each state of every cell; a suitable software routine will enable the system to check itself.

## Test programs

The author first decided on producing a test program for his MK14, SC/MP11-based microprocessor unit and has since generated a number of variations. Reproduced here are the original simple-approach listing for the SCMP and a more sophisticated version written in Pet Basic which is readily adaptable to other systems.

Both programs are based on the premise that it is necessary to test that all bits in all locations can be set to retain a logical one or a logical zero. The approach chosen is first to write 01010101 (i.e. Hex. 55; Dec. 85) check the location(s), then write 10101010 (i.e. HexAA; Dec 170) and again check the contents.

In the majority of cases this will produce an accurate indication of the quality of memory and enable fault conditions to be interpreted readily by

examination of the value of the contents returned at the two checks.

If it is suspected that certain patterns of data are causing peculiarities, either program could be adapted readily to check this. In addition in certain cases, e.g. when using dynamic memory, it may be necessary to insert a delay between the write and read operations to allow a "leaky cell" to be detected.

SCMP is the first version with no attempt at auto checking. All memory

**by W D Mercer**

locations specified in the program are loaded with Hex. 55; these locations are then checked visually on the MK14 seven-segment display manually stepping through memory. The program is re-run to load Hex.AA to all locations and the contents checked as before.

As shown, the listing is for the standard memory supplied with the MK14; the optional RAM may be checked by changing OF13 to OB; OF16 to OO; and OF24 to OO.

The Basic Pet listing given is for a fairly simple but nonetheless informative approach. The program could be expanded, e.g. to include Hex. as well as decimal readout of the location of faulty cells, or even to analyse the fault return to indicate which bits of the word are in error. All, however, entail a longer program; since the locations used for the program itself cannot all be checked because of the use of the POKE command, it is desirable to make the program as short as possible.

The locations used for the program

can then be checked manually from a program listing. As indicated the lowest "start address" must be above the highest location used by the program; on Pet this may be found by use of the FRE(0) function, remembering to allow space for the storage of the program variables.

Note that as given the program restores the original information to the memory after checking; this allows for this program to be used as a subroutine, checking locations which contain program or data information. If desired, this, together with the various "presentation" prints, may be omitted, resulting in a shorter and faster program. As given the program takes about one minute to check one kilobyte of memory.

## Running the program

As indicated, execution may be speeded by deleting lines 25 and 30 and the POKE statement of line 100. The FOR . . . NEXT loops in lines 40 and 70 act as delays of about 10 milliseconds as described in the text.

On a standard 8K Pet the following was obtained (initially? 8191-FRE(O) gave 129o, allowance for variables so START=1350)

```

RUN
MEMCHEK 02, WDMOCT78
START ADDRESS? 1350
END ADDRESS ? 8191
@2048
@3072
@4096
@5120
@6144
#6267>85< 84
#6331> 170<171
#6400> 170<174
#6461> 170<171

```

@7168  
READY  
!8191-FRE(0) gave 1332, hence minimum safe start address is 1336. This Pet had four faulty cells in the one memory section. Three had problems in BIT0, one in BIT2.

### Listing for SCMP

OF12	C4OF	LDI	Start	Loc.	Hi.	
OF14	35	XPAH				
OF15	C42B	LDI	Start	Loc.	Lo.	
OF17	31	XPAL				
OF18	C455	LDI	(55)			LOOP START
OF1A	CD01	ST	@1(1)			
OF1C	31	XPAL				
OF1D	C80C	ST	POINT			
OF1F	31	XPAL				
OF20	C009	LD	POINT			
OF22	02	CCL				
OF23	F407	ADI	7			
OF25	9CF1	JNZ	-15			ANOTHER LOOP
OF27	3f	XPPC	3			RETURN TO MONITOR
OF2A		POINT				

For second run change OF19 to AA.

### Listing for PET

```

5 PRINT"cl:"TAB(10)"MEMCHEK#02, WDMOCT78"
10 INPUT"START ADDRESS":A:INPUT"END ADDRESS ";B
20 FORI=ATO B
25 IF(I/1024=INT(I/1024))THENPRINT"@ "I
30 X=PEEK(I)
40 POKEI,170:FORJ=I TO10:NEXT:T=PEEK(I)
50 IFT=170THEN70
60 PRINTTAB(8)"# "I">170<"T
70 POKEI,85:FORJ=I TO10:NEXT:T=PEEK(I)
80 IFT=85THEN100
90 PRINTTAB(8)"# "I">85<"T
100 POKEI,X:NEXT

```



# Keen Computers, go SOFT!

A full range of **AppleII** software is now being developed:

## Software available at present:

Incomplete record accounting	£250	Shape-Create	£ 25
Addressing & Mailing program	£ 50	Co-Resident Assembler	£ 25
Word-processor	£ 50	Matrix Inversion	£ 25
Information retrieval system	£ 50	Full range of statistics packages	available from
Chequebook	£ 10		£ 35

In addition to these packages, we also offer a consultancy service.

## Hardware

**Keen Computers** are the only **AppleII** dealer in the Midlands area.

The APPLE II has to be the most advanced Micro on the U.K. market.

— It uses a 6502 microprocessor—a very updated version of the Motorola 6800.

— It has excellent colour graphics and a very comprehensive basic.

Apple II computer (16k)	£985	Disk unit without controller	£375
Additional memory	£200	Applesoft ROM card	£115
Disk unit with controller	£425	Printer card	£110

**Keen Computers** are now distributors of the new **attaché** micro-computer.

— 16K RAM—IBM format dual disks—from £1466.

Full range of printers available.

For further information please contact:

**Keen Computers Ltd,**  
**5 The Poultry,** (off Market Sq)  
**Nottingham**  
**Tele: Nottm**  
**583254/5/6**

● Circle No. 134

PRACTICAL COMPUTING February 1979



# Construction never less than excellent

THE CROMEMCO manufacturing company now makes a range of computers and boards using the Zilog Z-80 and the S-100 bus. A typical system with two mini-floppies and 32K bytes plus serial and parallel outputs will cost around £2,500. You can buy the 21-slot motherboard box containing the processor and a minimal amount of memory for £600. What you will be able to do with it is another matter.

The Cromemco equipment is more than just another S-100 micro box. There is a whole range of interesting boards and excellent software for the system. In this country the equipment is imported by Comart and distributed through a growing range of computer shops. Comart also makes MicroBox—an S-100 card frame (and a British S-100 product at last), which enables you to purchase a single-disc system for just over £1,000.

The Cromemco Z-2D is the top-of-the-range system with mini-floppies. A practical system to use the software efficiently would require 32KB memory. The processor and disc controller each occupy one slot of the S-100 box and there is a serial output as well on the disc controller, which means you can interface most terminals to your system immediately. Because of the way the software is configured, however, a second serial output probably is desirable if you want hard-copy output.

First, the good points. The standard of

design and construction of the boards is never less than excellent. They are double-sided, solid and well-made.

The manuals from Cromemco are also very well-produced—Cromemco uses its own word processing software—and would put many minicomputer companies to shame. The quality of documentation in the microworld is often little short of disgraceful, so this is no small achievement.

The single worst point about the Cromemco Z-2D is also immediately apparent. The mechanical design of the frame has been structured to make it easy

---

**by Richard Stevens**

---

to construct but it is inadequate for practical use. Immediate modifications are required to put the front panel on hinges for easy board access. A front panel re-set button and on/off switch are also very necessary.

The processing chip is based around the familiar Z-80A, normally operating at 4MHz but with a switch to operate at 2MHz for slower memories. It is also switch-selected to jump at switch-on to any 4KB boundary. The board is also totally compatible both in hardware and software terms with the Altair and Imsai cards, the Adam and Eve of S-100 systems.

The memory boards Cromemco supplies are not competitive for price with

those from the specialist manufacturers' and so Comart normally will supply the system with the Dynabyte 16 or 32KB boards.

By any standards, and especially by those of the micro business, the 32K board has proved very reliable, despite the fact that it gets *very* very hot during normal operation. It is not possible to move the 32K board in memory very flexibly. While one board is a good basis for a system, care therefore should be taken about systems which require PROMs at particular positions in memory.

The Z-80 can address only 64K bytes of memory but the Cromemco processor has the ability to select one of eight pages of 64KB of memory. The 32K board is not configured to operate in this way but the 16K memory is—and it can also put each 4K block of memory at any point in the 64K memory area.

The semiconductor memory can be write-protected, set so it is possible only to read the contents and not to write into it—it sounds a buzzer if you try.

So, all in all, the 16KB board is much more flexible, even though it occupies twice as many slots. These points may be academic for a system which it is to operate untouched on a shelf but they are vital considerations if you expect to be altering or improving your system in the future—and who doesn't?

The UK agent, Comart, is reported to

*(continued on next page)*

(continued from previous page)

be generally reliable and helpful—a pleasant change. In the last few months the company has apparently been so over-worked that the original level of good and rapid service has slipped a little, as it would admit itself. This seems to be one of the inevitable growing pains in the micro world and we would certainly not want to criticise Comart seriously because it has been significantly better than most micro firms with which our reviewer has dealt.

### Discs and Disc operating systems

The Cromemco Z2-D uses two Wangco mini-floppies costing around £1,400 with a disc controller. They are rather slower than the North Star discs Comart supplied formerly but they seem to be very reliable.

The Wangco discs are file-orientated rather than memory-orientated, which was the case with North Star. The Cromemco software is linked to the Wangco disc and is now much better at disc handling than the North Star version. It would no longer be sensible to choose North Star discs.

Each diskette holds 81K bytes accessed through CDOS—Cromemco Disc Operating System—. A system with one disc is not a really happy proposition unless finance, or lack of it, leaves you no alternative. The disc controller can handle three mini-floppies and has a serial and parallel port as well.

One particularly aggravating omission in the operating system is that there is no command for the complete copying of a disc from one system to another. On the other hand there is no specific "squeeze" command to compress the information on the disc to leave room for a large file; surprisingly, this happens entirely automatically.

CDOS has some sophisticated commands apart from the standard range you would expect. For example, the "batch" command enables the construction of a

series of CDOS programming steps which will then operate in an unattended mode—very useful for repetitive clocking through of a series of commands.

There is also a more simple monitor called RDOS—Resident Operating System. It operates as a primitive operating system for those unhappy souls condemned to work without a disc.

### Disc controller

The disc controller is a single S-100 card able to control any combination of up to three mini-floppies and four full-sized floppy disc drives. It contains a bootstrap PROM to enable CDOS to be extracted from the floppy disc automatically on power-up. Also on the board is a serial port for RS-232 or 20mA connection—and how is it all crammed on?

### Single-board computer

The single board computer is an interesting card which, with the addition of a power supply, can act as a self-contained computer. The big advantage of this is that it is entirely S-100 compatible. The whole program can be developed on the S-100 bus and then transferred into PROM, to produce a fairly cheap stand-alone system for process control applications. The single-board computer can be tested inside the Z-2 box before being moved.

At present the board is expensive at £345, presumably the level the market will accept but it is certain to fall in price. Cromemco control Basic and a program can be stored in two ultra-violet erasable PROMs—which, of course, can be programmed directly from the working program. With programming becoming more and more expensive and memory becoming cheaper, this combination is a sensible approach to system design for systems where only a few boards are required.

The board contains:

- Z-80A processor chip.
- RS-232 serial input/output.
- parallel data port.

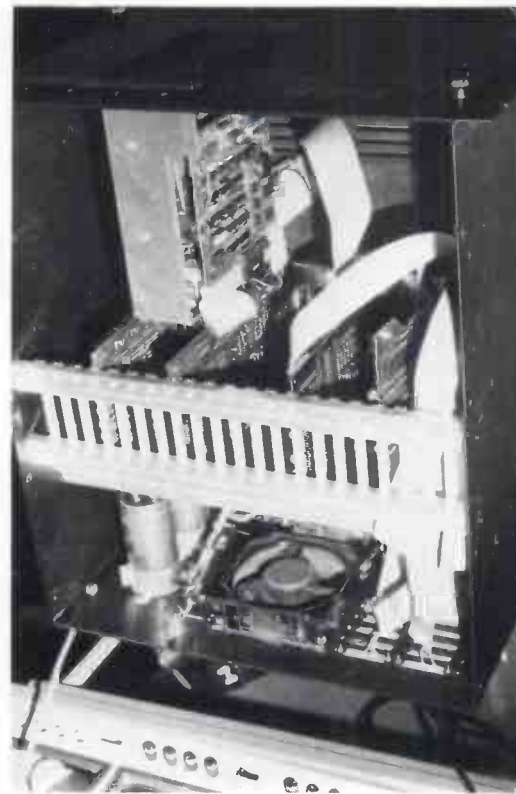

- room for PROMs.
- five programmable timers.

### TUART

This lovely acronym references the Twin Universal Asynchronous Receiver/Transmitter—the standard Cromemco board for inputting to and outputting data from the Z-80 processor. A terminal, Teletype or line printer normally would occupy one of the four input/output ports.

The board is packed with functions—a single 10 in. by 5 in. card contains two serial ports (RS-232C or 20mA) and two parallel outputs with 10 software-programmable timers, all for £185.

The baud rate is programmable from 110 to 76,500, a really useful feature which prevents you having to grope in the computer's innards to alter tiny switches.

There have been some reliability problems, however, with the TUART. This is strange because it seems well-constructed, even if rather full of components. David Broad of Comart told us that we had been unlucky and that there is no serious problem with the board. Indeed, the Cromemco equipment was voted the most reliable in a poll of U.S. computer shops last year.

It may seem like gilding the lily but in general it is our impression that the TUART could be improved significantly. If the board could store a buffer of, say, 128 characters while the processor is working, the programmer could type-in several lines of code which could run when the computer had finished accessing a disc. The mini-floppies used in the system are relatively slow and the operating system is configured so that the pro-

(continued on next page)

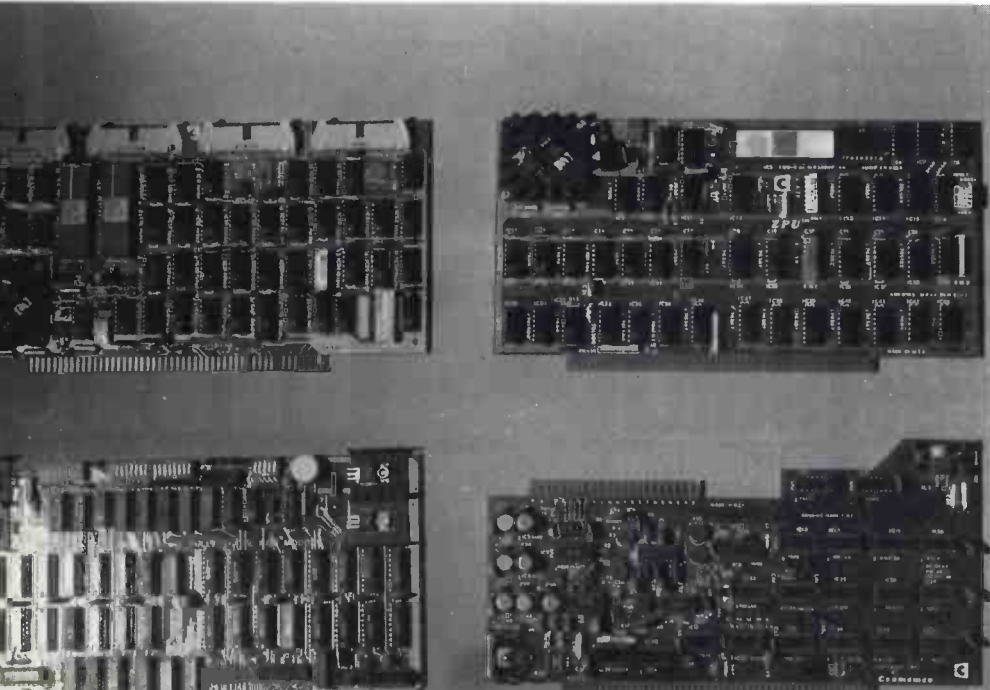



(continued from previous page)

grammer is often kept waiting for five to 10 seconds before something can be typed in mechanically; this time could better be spent thinking constructively.

Despite this niggling criticism, though, this board is a marvel of technology and a real bargain.

## Parallel board

This board is not one we have had occasion to use. It is for the analysis of digital data and contains eight 8-bit parallel ports for taking data into and out of the S-100 equipment. A useful little feature is an isolated input-output pair, with opto-isolated protection on the input and relay-protected output isolation—just right for electrocuting the mother-in-law by computer.

An essential pre-condition for buying one of these boards is an understanding friend with a flat-cable former. This is a really useful device for making a large number of connections to flat computer cable in one simple operation—our reviewer's soldering is so slow that it represents a 5,000 per cent productivity increase for making a 25-way socket.

## Software

The Cromemco software is becoming a very powerful collection indeed. There is Fortran; a very good semi-compiling Basic; a small Basic which needs only 3K bytes; word processing—the vendor is a little coy about this and prefers to call it “text formatting”. On the horizon are Cobol, Pascal and database management software.

None is at all sub-standard, even by comparison with their minicomputer brethren, and the manuals produced for them are excellent. Practical problems, however, are reported when running Fortran with the mini-floppies and only 162K bytes of total storage.

## Semi-compiling extended Basic

Basic was defined originally to be an interpretative language—that is, when the program is run, the original program is interpreted line by line. This makes the

programming easier but the processing time much slower than a compiler language like Fortran, where the program is reduced normally to machine code by a “compiler” before it runs. Even the slightest alteration in the Fortran program means that the whole must be re-compiled, a tedious process.

The 16K extended Basic is semi-compiling. This means that after every carriage return the program line entered is checked for syntax; each syntactic mistake is thus corrected by the programmer while the program line is fresh in the mind. The line is also interpreted at that time and placed into memory. This saves the same line being interpreted every time the program goes round a loop.

This makes for a very good compromise between a compiling and an interpretative language. Little of the flexibility of Basic is lost, yet the processing time is decreased significantly.

This version of Basic is very comprehensive and takes about 14KB for the interpreter, so to run a sensible system requires about 32Kbytes of RAM in total.

Among the features are extensive formatting capabilities (including the PRINT USING command); 14-digit precision, with the ability to reduce this if speed is preferred to accuracy; integer storage—very useful for storing large arrays; dynamic error trapping, which allows the printing of a pre-defined message on an error condition; easy interfacing to assembly language programs; and sensible disc input/output facilities. A full list of the Basic functions is included in the specification with this review.

## Control Basic

This software is a “mini” version of Basic, useful for those with small bank balances and memory, but intended mainly for implementing small programs very quickly on single-board computers. Despite the fact that it occupies a mere 3KB it contains a good selection of Basic functions, albeit in a stylised form.

Presumably Cromemco introduced investment in the form of programs in the language. This version conforms in full to

the American National Standard Version of 1966 and so should be more or less compatible with any programs running on older machines.

If you intend running Fortran programs, the full-sized floppies, with 250KB capacity, are probably a better bet than the mini-diskettes; Fortran always seems to finish by taking an enormous amount of disc space for one thing and another.

The compiling speed is several hundred statements per minute, surprisingly fast really. The Fortran program is composed using the Cromemco Text Editor, a program whose commands bear similarities to TECO, the *de facto* standard used by Digital Equipment; in one or two points the Cromemco editor is superior. Editors are used so intensively by programmers that it would be highly desirable to standardise on one set of shorthand commands for all editing systems. The same editing system is used for entering text for the text formatting software.

## Macro assembler

Cromemco really went to town over this system for writing Assembly language programs and it is as good as any micro assembly software.

For a start, it is re-locatable—a very useful feature and difficult to implement because of the nature of today's micro-processors—both Intel and Zilog have learned the lesson for their new 16-bit machines.

A macro is a little set of assembly level instructions which can be grouped into one self-made instruction, which can then be used on its own. A library of common macros can then be formed and used. Macros have much in common with sub-routines but they may have significantly different effects in use.

The debugger, another chunk of software associated with this package, enables the disassembly of any program into the mnemonics of assembler language. Of course, neither the labels used by the original programmer nor the programmer's comments are available but disassembly is an extremely useful tool.

The contents of memory may be altered

(continued on page 35)

## Technical Specifications

Dimensions: 19 in. rack-size width x 13 in. high x 21 in. deep.  
Weight: about 50lb. depending on configuration.  
Memory: expandable to 64 Kbytes.  
VDU: Any, conforming to RS-232 or 20mA loop conventions — e.g. Lear-Siegler, Lyme, Newbury, and the like.  
Storage: Mini-floppies with 81 kbytes per diskette; 8 in. floppies with 256 kbytes/diskette.

### Operating Systems:

RDOS: simple commands to examine, change, or move memory. Primitive disc-copying facilities.  
CDOS: Cromemco Disc Operating System; good file-oriented operating system used for initialising discs of transferring files.

### Languages:

FORTRAN: to ANSI 1966 standard.  
SEMI-COMPILING EXTENDED BASIC: comprehensive set of commands, good file-handling functions: LET REM INPUT READ DATA RESTORE PRINT PRINT USING SPC TAB FOR-NEXT IF-THEN GOTO GOSUB

ON ... GOSUB DIM STOP END PEEK POKE SYS DEF FN USR INP OUT ON ERROR LIST RUN DELETE AUTOL RENUMBER CON SCR SAVE LOAD ENTER CREATE ERASE TRACE/NOTRACE ECHO/NOECHO ESC/NOESC/JON ESC SIN COS ATN TAN RAD DEG ABS EXP FRA FRB INT IRN LOG MAX MIN RANDOMISE RND SGN SQR ASC CHRS LEN POS STRS VAL OPEN CLOSE PUT GET PRINTINPUT-IOSTAT  
CONTROL BASIC: mini (3Kbyte) version, ideal for storing on PROM with a reasonable selection of commands.  
Functions: CALL PRINT LOCK LOC NEXT AND LET STEP TO GOSUB REMARK SGN EPROM PUT OR NEW NULL GET LIST STOP WIDTH IF RUN XOR FOR QUIT RND OUT IN LOAD ABS INPUT SAVE GOTO RETURN SIZE  
EDITOR: Used for creating FORTRAN and TEXT FORMATTING files.  
MACRO ASSEMBLER: comprehensive package (including TRACE and DEBUG) for writing and debugging assembly language programs.  
TEXT FORMATTING: Good package for handling text for reports. All standard facilities, including ability to leave space for diagrams, page headings and numbering.

## U.K. Dealers

Computabits Ltd, 41 Vincent Street, Yeovil, Somerset (0935) 26522.

Newbear Computing Store, 7 Bone Lane, Newbury, Berkshire RG14 5SH (0635) 46898.

The Byte Shop Ltd, 426-428 Cranbrook Road, Ilford, Essex IG2 6HW (01) 554-2177.

Xican Systems, 31 Elphinstone Road, Highcliffe, Dorset BH23 5LL (04252) 77126.

Computer Workshop (Manchester) Ltd, 29 Hanging Ditch, Manchester (061) 832 2269.

Comart, PO Box 2, St. Neots, Huntingdon, Cambridgeshire PE19 4NY (0480) 215005.

## Prices

Typical system configuration:  
Z2-D Software Development System: Chassis, power supply motherboard, CPU card, six sockets and fan, £575.

Disc: controller and disc, £845.

32 Kbyte RAM, £695.

Either FORTRAN, MACRO, BASIC, £85; Total price (Assembled), £2,205.

# ELECTROVALUE

APPOINTED NATIONAL DISTRIBUTORS

## NASCOM 1 MICROPROCESSOR KITS

- ★ For Delivery from Stock
- ★ Full supporting Programme of NASCOM Equipment
- ★ Quantity Discounts
- ★ Service you will Appreciate

Franchised  
Distributors for  
**SIEMENS**  
**MOTOROLA**  
**MICROPROCESSORS**  
**ISKRA**  
**RADIOHM**  
and other brand names  
famous for reliability

**PRICE LIST AND INFORMATION**  
Gladly sent on request. Your name will be fed to our computer for use immediately our new catalogue is ready.

### ELECTROVALUE LTD

Dept. PC 12, 28 St Judes Rd, Englefield Green, Egham, Surrey TW10 0HB.  
Phone Egham [389 from London: STD 0784-3] 3603; Telex 264475.  
Northern Branch (Personal shoppers only) 680 Burnage Lane, Burnage, Manchester M19 1NA  
Phone [061] 432 4945.

● Circle No. 135

# GAMES GAMES GAMES GAMES

## COMPUTER GAMES & BOOKS

- BASIC COMPUTER GAMES**—101 games in Basic. Microcomputer edition ..... £5-50
- COMPUTER RAGE GAME**—2-4 players, 9-adult board game. Board, pieces, binary dice, interrupt cards, etc. £6-95
- CREATIVE COMPUTING MAGAZINE** — Games, puzzles, projects, fiction, articles, humour, cybernetics, building info and more. Sample copy ..... £1-50
- BEST OF CREATIVE COMPUTING Vo. 1**—328pp compendium ..... £6-95
- BEST OF CREATIVE COMPUTING Vol. 2**—328pp compendium ..... £6-95
- BEST OF BYTE**—Taken from first 12 issues of 'Byte' mag. Theory, applications, speculations, projects, software systems, etc. 384pp ..... £8-95

## Science fiction and fantasy BOARD & TABLE GAMES

We are specialists in the rapidly-expanding Science Fiction Games hobby. For our illustrated games catalogue, introductory literature and illustrated miniature figures catalogue, send 30p in stamps + a large SSAE. Some of our best sellers are:

- DUNGEONS & DRAGONS**—The game that started it all. A completely new type of game in which players become Wizards, Heroes and Thieves in quests for hidden treasures guarded by fearsome monsters. Boxed set ..... £7-50
  - STARSHIP TROOPERS**—Based on Heinlein's novel. Strategic game of tactical warfare on alien planets ... £8-95
  - COSMIC ENCOUNTER**—2-4 player game of planetary invasion in which each player is an alien, each with its own unique powers ..... £7-25
- All price include postage and packing (UK only)

Games Workshop  
1 Dalling Road, London W6  
01-741 3445

# GAMES Games GAMES Games

● Circle No. 136

# MICRODIGITAL OF MERSEYSIDE

The Microcomputer only shop providing a complete service from a single chip to a commercial data processing installation. Well worth a visit for a look around and a chat.

## THE LATEST MICROPROCESSOR PRODUCTS FROM MICRODIGITAL



**BORIS IS KING.**

**TIME TRAC.**

## MICRODIGITAL LTD.

25 BRUNSWICK STREET  
LIVERPOOL L2 0BJ  
Tel: 051-236 0707

**OPENING HOURS:**  
9-5.30 Monday to Saturday.  
Friendly, expert staff always on hand!

### BORIS IS KING

Boris is the world's most advanced portable chess computer:

1. Programmable Positioning — allows you to position the chess pieces at any starting position.
2. Handicapping — you may programme Boris to remove any piece you wish for handicapping.
3. Illegal Moves — Boris checks for and rejects illegal moves.
4. Castling — Boris both castles and recognises castling.
5. En Passant — Boris Both recognises and uses En Passant.
6. Queening — Boris automatically queens when a pawn reaches the 8th rank.
7. Colour — Boris can play black, white or both. Yes, Boris can play himself.
8. Handcrafted Case — Solid walnut, hand rubbed oil case. Chessboard and chessmen included or use your own.
9. Conversation — Boris talks to you with messages programmed into his brain.

**£199.00**

### TIME TRAC

A microprocessor controlled quartz desk time piece Time Trac has:

1. 15mm Vacuum Fluorescent Display.
  2. Mains operation with lithium power cell standby.
  3. Memorises 30 appointments in any combination of:
    - (a) Alarms.
    - (b) Future appointments.
    - (c) Daily appointments.
  4. Elapsed time stopwatch.
  5. Countdown stopwatch with audible alarm.
- Prices include V.A.T. and Carriage. **£39.95**

Phone in your Access/Barclaycard Number on **051-236-0707** or complete this order form

PLEASE SEND ME:

COMPLETE AND POST TO THE ADDRESS ABOVE

I ENCLOSE:

CHEQUE/POSTAL ORDER NO.....

BARCLAYCARD NO.....

ACCESS CARD NO.....

NAME.....

ADDRESS.....

(continued from page 33)

in real time by typing in assembly language. Trace facilities enable the programmer to move slowly through the program at the machine instruction level. Break-points can be set to occur at suspicious points and the registers and memory examined.

### Text formatting

Cromemco avoids the use of the term "word processing" because this software is not meant for people unfamiliar with the text editor. A day or two would be required to familiarise yourself with this package but afterwards it will remove all the drudgery from report writing, especially if you are one of those people who always seem to need give one more correction to any piece of text. Right-hand margin justification, automatic page numbering, stopping the typewriter after each sheet has been processed, text in double columns—it all seems to be there.

A point worth noting is that the word processing software is written to take advantage of the Cromemco line printer, a parallel input device with great flexibility and high-quality daisywheel output. It can do things like underlining and overprinting, and it even adjusts the words in a justified line so that the spaces between them look exactly equal. This is not possible with a normal terminal, which does not have the ability to move a fraction of the space of a letter.

Such printers are few and far between—most people will be lucky to have access to a cheap serial printer. To get these to work requires a slight modification to CDOS—details soon.

Control of the printer is, of course, automatic in the text formatting system but a hard copy of the VDU output can be obtained by pressing Control P at any time.

### Other boards

Cromemco makes a series of boards which illustrate the flexibility of the S-100 bus. If you buy S-100 equipment, you have access to the products of dozens of manufacturers, all in cut-throat competition with each other; despite this, one or two Cromemco boards have become near-standards.

If you want to take in signals from the real world, do something with them, and then tell the world what to do, the A-D board is the thing for you. There are seven analogue channels with seven for output, and a digital input and output as well. And it is usable from Basic as well. The analogue channel is sampled to eight bits and appears as a value between 0 and 255 with a simple INP command; similarly, an eight-bit value can be sent to an output port with an OUT command.

What you do in between is up to you. Even by minicomputer standards, this board is no sluggard; it has a five-microsecond conversion time, which compares well to the minicomputer equivalents. For process control of equipment this board is absolutely ideal.

The Bytesaver board is one of those well-known Cromemco offerings. It is for programming and using programmable read-only memories and is based around the industry-standard Intel 2708/2716 chips. Once the chips are programmed they retain their data almost indefinitely, until exposed to a powerful ultra-violet light. The board is very easy to use and software commands which transfer data from RAM to the PROM are built into the operating system software. The original Bytesaver—still available—holds 8KB; the new version will hold up to 16 of the 2KB 2716s, if you can afford them.

The Dazzler is a pair of boards now more than three years old, a veteran by S-100 standards. Essentially it is an interface to a colour TV enabling the generation of 64 x 64 resolution colour pictures. Unfortunately, it was designed for American TV standards, though it will work—after a fashion—on British equipment.

It is probably not worth considering now Cromemco is certain to produce a better version in the near future and in any case for the present there are better S-100 graphics boards on the market. The poor resolution is a hindrance to any delicate work but some spectacular programs, such as a dramatic ever-changing kaleidoscope, have been generated.

### Cromemco System 3

The de-luxe end of the range is the Cromemco System 3, a posh version of the Z-2D. Not only is its paint job much better, it has full-size floppies (up to four) and its beautiful mechanical construction makes its cheaper brethren look badly dressed. The S-100 bus slides out on a neat rack for easy access. The software is absolutely identical to the Z-2D.

The price of this system, at around £4,000, is approaching that of a similar 16-bit micro like an LS1-11 configuration. Discussions on the relative merits of the two systems is outside the scope of this article but in passing it is worth pointing out that the LS1-11 probably has the superior operating system—after all, it has had longer to evolve.

A budget version of the Cromemco System 3 would be the Z-2 with some external floppy disc system giving full-sized floppies at some discount.

Coming soon—

A logical addition to the Cromemco range would be a rigid disc, a cartridge able to store something like 20-40 megabytes. This is essential for any

large-scale record storage—mailing lists, for example, or writing the Great English Novel with your text formatter. Remember to keep back-up copies—it would be awful to wipe it all out on page 887.

A much better graphics display option should also be on the way: this is the main weakness of Cromemco compared to some other equipment, especially the Apple II, of course. Hopefully, Cromemco will remember the UK television standards at the design stage: if not, there might be another golden opportunity for a British manufacturer to miss.

### Conclusions

- Cromemco has assembled a fairly powerful system with very good software and a fine operating system—much more important than any differences in hardware.
- Not the least of its advantages is the flexibility of buying an S-100 kit, giving you access to the equipment supplied by more than 100 other manufacturers of hardware, boards and software.
- No one firm can charge you too much for any single piece of equipment, at least not for too long. If anyone should sneer at slight incompatibilities between some S-100 equipment, ask them to name equipment for their system you cannot get for the S-100 bus.
- The Cromemco kit is bulky, with 21 S-100 slots available. No power-supply problems are likely because of the conservative design of the equipment. The well-developed and well-presented software will make it a tempting proposition even if the size of the equipment is something of a deterrent.
- For someone who would be content with a smaller, neater, cheaper system with fewer slots, there are many alternative S-100 systems on the market which might make for a reasonable comparison.

# OHIO SCIENTIFIC

The State of the Art in Small Computers.

Following the successful launching at Compec, we are pleased to announce that the full range of **OHIO SCIENTIFIC** machines is now available, with good delivery. Example systems are: (The C2 4P with mini-floppy, 20K RAM, and personal, games, business and educational discs; and C3 OEM with twin standard floppies, 32K RAM, and a range of optional languages.

C2 4P—MF—£1,595

C3 OEM £2,950

**ABACUS COMPUTERS LTD.**  
**62 NEW CAVENDISH ST.**  
**LONDON W1M 7LD**  
**01-637-0777**

**DEALER ENQUIRIES WELCOME**

● Circle No. 138

**dam's**  
 Computer Division

## Commodore - Tei Ohio Scientific - Compucolor

The following is a selection from our large stock

<b>PET SERIES</b>		<b>APPLE 16K</b>	£985.00
Pet 2001 8K	£643.52	Apple Disc	£425.00
2nd Cassette	£55.00		
Unidirectional Interface		<b>COMPUCOLOR 2</b>	£1331.93
I-EEE to RS232	£99.50	8K, Colour VDU, with 80K disc	
Bidirectional Interface	£175.00		
DAMS Joystick (with software)	£25.00	<b>OHIO SCIENTIFIC</b>	
DAMS Page Printer Interface (to 20m.a. loop)	£25.00	Superboard 2	£296.00
DAMS 625 Video Adaptor (complete for TV or Monitor)	£25.00	500 Board	£285.00
		<b>KIM 1</b>	£99.95
		Kim 3B (8K exten)	£129.95
		Kim 4 (Motherboard)	£69.95

All prices exclude VAT.

We stock Manuals, Documentation, all CBM & Petsoft software. DAMS software includes specialist scientific, mathematics routines and games for Pet all at £4.00 + VAT. Send S.A.E. for comprehensive catalogue.

### TEI—Professional Systems

8080 based, CP/M, Mixed disc drives, Cobol, Basic, Fortran 4, Pascal. Standard and Personalised packages for Stock Control, Accounts payable, Accounts Receivable, Word Processing etc, for the commercial user.

Please ring Graham Knott or Jeff Orr for details or demonstration.

DAMS (Office Equipment) Ltd.  
 30-36 Dale Street, Liverpool, L2 5SF  
 Sales 051-227 3301 (10 lines)

● Circle No. 139

# XITAN SYSTEMS

Southern England stockists for **CROMEMCO**

Selected nationwide by Government departments, Research Establishments, Universities, Professional Consultants, Assurance Companies, Industry and the serious hobbyist. Features include a range of software equalled by no other manufacturer for price and performance. Fortran, Basic, Cobol, Z-80 Macro Assembler, Trace, and Word Processing, all at only £85 each. Xitan Systems can supply CP/M for use on Cromemco equipment with 8 in. floppy discs.



*THE machine for professional use*

XITAN SYSTEMS, 23 CUMBERLAND PLACE, SOUTHAMPTON SO1 2BB. TEL: (0703) 38740

Also suppliers of: PET \* HORIZON \* PT SOL \* DYNABYTE MEMORY \* BOOKS \* VDUs \* PRINTERS

● Circle No. 140

# Payroll and the Pet

WORKING-OUT the payroll is one of the most boring chores of any business. With the complexities of calculating PAYE and National Insurance, most organisations are only too willing to leave it to a book-keeper or accountant.

It is these repetitive calculations, however, together with the need to store data, which makes it an ideal application for a computer.

Many of the letters to our Feedback columns have asked how payroll could be handled cheaply. To be honest, to buy a computer just to work out payroll for fewer than 10 employees is hard to justify.

One of the cheapest approaches we have found is to use the Pet (£695) plus some payroll programs (£25) which have been written for it by an accountant. Although you could run your payroll without a printer, it is much simpler if you have one and the cheapest is around the £400 mark at present—total cost, around £1,200.

## Hire service

For that you would have a system which could handle up to 100 employees quite comfortably. Above 100 employees it is probably better to use a disc-based system, for which you would be spending upwards of £2,000.

Payroll, of course, is not the only appli-

cation which a computer could run. Apart from playing games, you could run other accounting procedures on it, which helps to justify its purchase.

As an aside, you can now hire disc-based computers for around £40 a week and the resultant time-saving may well be worth the money.

The Pet payroll system is in two versions: Series A is for machines with only one cassette deck and Series B is for twin cassette deck operation.

The Series A suite will cope with 10 employees per cassette tape. It will work whether or not you have a printer and can handle monthly or weekly-paid staff. It can accommodate two overtime rates, short time (unpaid leave), staff loans and automatic deductions, and three National Insurance rates (A, B, or C).

The Series B suite will handle everything the A suite can do, plus hourly-paid employees, three overtime rates, hourly bonuses, non-taxable expenses and up to 100 employees per data tape.

The Series A suite of programs consists of three parts—create and change, copy duplicate and print, and payroll. Create and change is used to create and update the employee data file. Duplicate allows the user to take a back-up copy of the employee file on a separate cassette, so as

to reduce the risk of losing valuable data. The print function is used to obtain a print-out on hard copy of any employee data.

Payroll performs the calculations. It is done by typing-in the file name, the current week number, the number of employees held on the tape, after which the program prints-out an employee name and asks for variable data concerning the employee.

Depending on your computing experience of using the Pet and payroll, it is advisable that you begin with the Series A program, since it holds less information and if, an operational failure should occur, it will be easier to input data in again in the Series A program than the Series B program.

## Updating

The system provides for placing output on a printer as well as a VDU. The output of the payroll program can be used directly to prepare payslips for the employees on the data file. If you do not own a printer, it is suggested that you prepare payslips in the format of the printout on the VDU, and copy the data as it appears on the screen.

Both programs are well-written, though rather complex to run. The complexity is not helped by the standard of the documentation which, though reasonable, has considerable scope for improvement. We are informed, however, that new and improved documentation is being written.

The programs require a great deal of manual manipulation which makes them, in computing time, rather slow. This, together with the complexity of running the program is principally the limitation of the complete system rather than the software.

Despite these minor criticisms, the program should enable the businessman with a Pet to reduce considerably the amount of time spent on payroll, as well as avoiding headaches due to excessive calculation.

The author of the programs also runs an updating service to take into account any new laws or changes to PAYE instructions. It costs £10 a year.

# Postscript to Mastermind

THE ARTICLE, "How to Play Mastermind", in our November, 1978 issue described and presented a program for the 6502-based KIM microprocessor system to play the game Bulls and Cows, now better known as Mastermind.

Once the standard game has been mastered, a simple modification will convert the program to play a much more difficult variant of the game, known as Parity Bulls and Cows.

In this version the guesser is not told the numbers of Bulls and Cows between his guess and the code, but only whether each of these is odd or even; the reply is "1" if the number is odd and "0" if it is even.

Thus to a code string "0123" the reply would be "00" for the guesses "4567", "3266", "0166", or even "3210", whereas in the standard game they would all be distinguished by different replies. When the guess is correct, the reply "40" must be given. The modifications are as follows:

```
022D 4C D6 03      JMP PATCH
03D6 A5 D6      PATCH LDA COWS
03D8 29 01      AND £1
03DA AA          TAX
03DB A5 D5      LDA BULLS
03DD 29 05      AND £5
03DF 60          RTS
```

When playing Parity Bulls and Cows

the program needs, on average, about 10 guesses to get your code string.

The graph showing the performance of the original Bulls and Cows program over a sample run of 1,000 games was accidentally omitted from the original article, and is now reproduced here. The program needs on average 5.74 guesses and all the codes were guessed in nine guesses or fewer.

Finally, an error occurred in the program listing; the data at 0200 should be: 4C A8 02 (not 4C 48 02). The remainder of the listing as published is correct. □

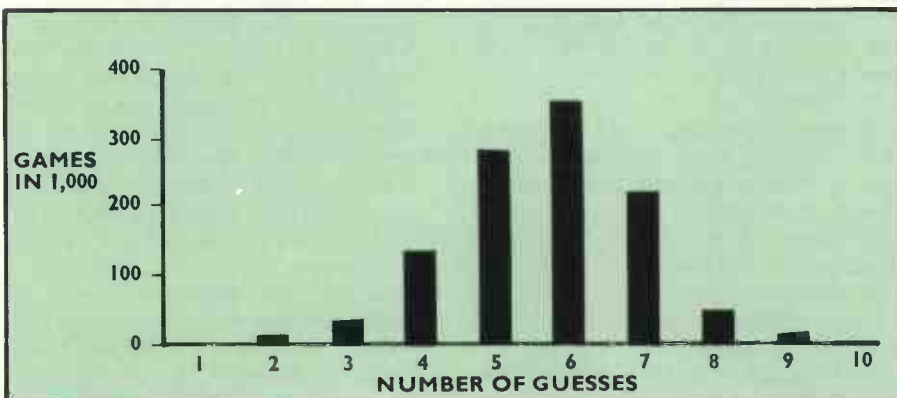

# Avoiding major items of expenditure

For the small development company or indeed for the amateur, most of the microprocessor development kits require one major item of expenditure which can more than double the cost of a development system—the Teletype device used for the main human/microprocessor/human communication.

EVEN the 'glass Teletypes' (VDUs) now beginning to proliferate at lower costs are still not cheap enough by comparison with the cost of the actual user kit.

For example, it is possible to buy several micro systems at less than £500 each, while a new ASR33 Teletype or Silent 700 terminal will cost more than £1,000 and a VDU will cost about £500.

The micro was designed as a simple replacement for a box-full of TTL or even mechanical logic in such applications as control systems, amusement arcade games and intelligent data transmission systems. Obviously none of those products is likely to use a Teletype as the I/O medium in the finished article, so the use of a Teletype in the development of such products is not only expensive but also questionable.

## Best approach

Bywood Electronics was confronted with the problem of getting its own micro units up and running and at the lowest cost and although it had programmers on the staff, they had only IBM experience. It was decided eventually that the best approach was to take a micro chip and add as few extras as possible it to get a minimum system running, so that the capabilities of micros could be investigated.

This simple system used LED lamps to show the status of the 8-bit data lines, the 12-bit address lines and four single-bit I/O lines; so as not to load the MPU busses unduly the LEDs were run from CMOS drivers.

Bywood is a company which specialises in the supply of LSI technology components to small-volume users. To ease the design of equipment based on these components, a set of simple kits was designed for such things as digital clock timing and counting circuits.

The typical customer was either an amateur constructor or a designer developing a larger piece of equipment who did not have the time or resources to inves-

tigate the chips from first principles.

One of the first applications for its own development kit, SCRUMPI, was to make the I/O of instructions and data by more experienced micro designers a little easier and faster. As the micro talks only in Hexadecimal codes, there are only 16 numeric keys required (0-9 and A-F) plus a few operation keys such as RUN, STEP, RESET, and the like.

The digital LED type of display used in some micro kits is limited by the number of digits (usually 6 or 8) and the fact that the seven-segment type of display severely limits the number of understandable non-numeric characters which can be displayed.

It sought a low-cost, quiet, legible output device capable of displaying textual messages which were not so stylised that a layman would have difficulty in understanding them. The idea of using a video output to a TV monitor or commercial TV set is new and as it had already designed and sold several types of VDU character-generation systems, it decided to cost a minimum configuration.

## Several basic units

This type of VDU contains several basic units:

TV synchronisation signal generation.

This part of the circuit generates the line and frame sync signals used to synchronise the 'picture' on the screen. It has to generate a line sync and the necessary blanking signals every 64µs and the similar frame signals every 20ms (figures refer to 625-line TVs).

Within the visible 48µs horizontal time it has to define a number of character slots and similarly define a number of character rows in each visible vertical scan.

Within each character slot it has to define a number of horizontal dots and vertical lines, each to include inter-character spaces.

Each character slot has to be able to dis-

play several (in fact, 64) characters, made up from light and dark dots and lines.

A memory is required to remember the character required at each of all the possible character locations defined in the second item. This memory must be accessible by the VDU and by the MPU.

The keyboard has to be low-cost, simple to assemble and use, but still give as many character code inputs as possible. Bywood decided to run the keyboard as a 16-key block, plus four 'mode' keys and an interrupt key.

## Decoding by micro

The decoding of the code from the key depression(s) was to be done by the micro rather than using an external encoder to save on-costs, component count and to give maximum flexibility. Thus in the end-product the designations of the keys are controlled by the software and can be labelled to user requirements.

One example uses the INT key to simulate a Carriage Return/Line Feed function used to indicate the end of a human-to-micro command string or operation. The 16-key block is used to define characters in the 64-character ASCII set and three of the mode keys define which part of the ASCII set the 16-key block defines.

In this example it is possible to enter 65 codes by use of only 20 of the 21 keys available. The keys could be re-labelled for control functions which are completely unrelated to the ASCII character set.

## Single address location

To the micro the port looks like a single address location at which it can read or write data; the micro addresses the port physically by decoding an address strobe from the address bus. Any time that this

*(continued on next page)*

(continued from previous page)

address is accessed the strobe will become active and thus inform the port that it is being accessed and should thus take appropriate action.

To the engineer and to external equipment, the port looks like an 8-bit TTL latch. When used for output, the data on the micro data bus is latched into the port and thus appears latched at the port output pins; from there onwards these outputs can be assumed to have come from any similar TTL type of device.

When used for input the port becomes an 8-bit latch presenting its inputs to the external circuitry; usually one of the inputs or an additional control pin acts as the clocking input.

### Interfacing

Data is presented to the port inputs and latched by strobing the clock input; the data at the inputs can then be released as the data is now held in the port. At the same time the micro is informed—or finds out for itself—that there is new data in the port; it can thus 'read' the port address which will enable the port outputs to deposit their data on to the data bus and thus into the micro chip.

In applications of this type, the micro would then signal to the port that it had read the data and that the port could in-

put some more. This sequence of "I've got some data for you", "Thank you, I've read it" is called 'Hand-shaking'.

A very simple example of interfacing to a micro via a port is the type of hand control used in TV games for 'bat position'. This is a simple potentiometer and as such cannot be understood by a port or any other TTL circuitry. To interface a potentiometer to a micro we can use a simple monostable such as a 555 timer or a 74123.

With this type of IC a trigger signal causes an output signal to change state. After a time, this output will revert to its original state, the time being set by an external capacitor and resistor network.

Taking an example of such a circuit where at one end of the travel of the potentiometer the output changes state for 100mS and at the other end the delay is 200mS, there is a variation of 100mS. The trigger of the circuit is connected to a port input. The micro can thus trigger the monostable and then delay for a fixed time to compensate the first 100mS. If the micro then performs a program loop which reads the port input bit until the monostable output reverts to its original state, there is:

```
START: Set Trigger.
        Delay 99mS.
        Set Count to zero.
LOOP:  Read input bit.
        If changed go to END.
        Add 1 to count.
```

Delay rest of 1mS.

Go to LOOP.

END: At this point count contains 0-99 which represents a setting of the potentiometer.

The count at the end can be used as a variable in a program, which can thus know the current position of the potentiometer and even its rate of change.

The potentiometer obviously can be changed for any other form of variable resistor—thermistor, LDR, pressure transducer—or in a similar manner with variable capacitance, voltage or current.

Similar circuits in reverse can be used to allow a micro to output a variable voltage and thus perform such tasks as heat or speed control, or something as simple as playing tunes.

### Simple tasks

The more usual output requirement is as a switched output, either as a pulse train or as a single ON/OFF switch. The pulsed output can be used to input the TTL-type circuitry, such as a counter chain, for use in such things as IC testing. Here the CLOCK, RESET and LOAD signals can be simulated by the micro which can also test the outputs from the counters or other ICs and thus check a PCB or a single IC much faster than a human being. □

# Mind your own business...

## ...with a Bondain Book-keeper.

The Bondain Book-keeper brings big business benefits without breaking budgets.

Whatever your problem we've got a complete solution you can afford.

The Bondain Book-keeper includes complete systems for Stock-Control, Invoicing, Sales Ledgers, Statement Preparation, Debt Dating, Purchase and Nominal Ledgers.



Total cost under £2000 a year.

Head Office:  
Sumlock-Anita House  
15 Clerkenwell Close  
London EC1R 0AA.  
Tel: 01-253 2447/8  
Telex: 299844



# Behind these walls there's a posse of programmers



PUPILS AT Longfield School in Kent choose to stay regularly after school hours to use the school computer. That caused a certain amount of jaw-dropping in the reporter we sent to Kent, not least because her memories of her own school-days were rather different.

Longfield is a comprehensive with 1,400 pupils aged 11 to 18; it will soon become an Upper School for 13- to 18-year-olds. What makes it unusual is its thriving computer department, characterised by a high degree of pupil participation.

In June, 1977 the school acquired an ASR33 Teletype as the first step to a link with the county computer. It was soon discovered that this was unsatisfactory. The county computer was restricted to 16 inputs at one time; timetable clashes were inevitable; the method was clearly unsuitable for mass-teaching. Children require an instant response or they lose interest.

## First step

Then, while on a trip to the U.S., maths teacher Mike St John saw the Altair 880B. He promptly bought a kit and assembled it during the summer holiday. The system was completed with two cassette units and an ex-ICL 30 cps printer. On October 27, 1977 the system was up and running and the first program was keyed in—it was a program written by a sixth-former to print multiplication tables.

The next step was to obtain some paper-tape punches, the aim being to give hands-on experience to as many children as

**Question: How do you get children to stay willingly at school until 6.30 p.m.**

**Answer: Get a computer.**

possible. Hard copy of some kind is also necessary for examinations and assessment.

The Longfield method of acquiring extra equipment is remarkable. Very little public money has been spent. Parents have been able to help, either by giving the odd roll of Teletype paper or by finding donors of equipment; it seems that banks have been very generous, which rather belies their public image.

St John explained that the school can accept anything, modifying any piece of hardware to run on its system. Not only have people been generous with materials, they have also contributed a good deal of their time. For example, an ICL engineer who lives locally carries out repairs.

The need to time-share led to the acquisition of a disc drive. Two Soroc VDUs were also bought. They were all paid for by writing software, for local businessmen and for Altair.

A payroll program was written for Altair. It was broken into modular units; the students dealt with the parts and St John put together the program. Altair credits the school account, as it is not money but hardware which is needed.

The configuration now consists of the

Altair 880B (64KB memory), twin floppy disc drives, cassette units, the Teletype printer terminal, the ICL 30 cps printer, two display terminals and six off-line paper tape punches.

St John explains that he chose the Altair because of its flexibility and multi-user capability. The system can support up to eight terminals and Altair is developing software which will handle up to 20.

He would like to see a classroom of pupils each with his/her own terminal. "Less than that", he says, "is only making do."

## Full of praise

He is also full of praise for the supplier's "excellent service". The response in cases of downtime has been immediate and thorough—vital where youngsters are concerned.

Installed in a classroom, the system has three functions within the school—as a study in its own right; as a service to teaching; as an administrative tool.

The computer generates remarkable enthusiasm among the students. The school offers Computer Studies at O level; there are 28 on the course. In the sixth form, 14 students take computing as a "recreational" course.

Then there is a flourishing computer club. Surprisingly for a modern comprehensive, very few girls opt for computing; the one girl whose work was mentioned was writing a recipe program.

In the computer club the pupils

*(continued on next page)*



(continued from previous page)

examine the history and basic principles of computing. They also learn what happens inside and develop engineering skills. Visits arranged for the eager hordes include the British Science Museum, the Kent County Council mainframe, and trips to offices and factories to see and compare manual and computerised methods of administration.

All programming is done in Basic, a powerful language with the advantage of being transferable easily between systems.

The computer room impressively organised. It is run like any commercial dp department, with a job specification sheet; every group using the computer has a system of job allocation. For example, each group has an environmental control officer, librarian, systems manager, software controller, supplies officer, and even a public relations officer.

### In control

The staff members involved try and stay in the background and let the pupils "fire each other with enthusiasm". Gabrielle Hayes, who teaches English, considers the appeal of programming derives from the student's feeling that he or she is in control. The atmosphere in the computer room is lively, relaxed and friendly—traditional staff-student relations have disappeared in this area of school activity.

The fact that the computer runs 12 hours every school day must be some indication of its popularity. The students spend breaks, lunch hours, and after-school time keying-in and punching.

Children often write programs at home, not as homework, but on their own initiative.

Around 6 pm St John insists the system be handed over to him and Gabrielle Hayes, so that they can work on developing the computer's second role, that of a teaching aid.

Miss Hayes first had the idea of teaching



through computers when she was working with disadvantaged children. She found that the stimulus of a computer resulted in real progress. With a child of any ability, the use of a computer, especially with a VDU, increases the pupils' attention and develops powers of concentration.

Moreover, the novelty of working with a computer pays off. Children behave for the reward of a turn at the keyboard. Also, as headmaster Harold Darby points out, computers have the same potential as typewriters in encouraging English skills.

Gabrielle is working on programs to be

used in teaching English. Preliminary work has been done on the teaching of spelling, a lesson, she says, which that can be boring and repetitive.

### Spelling lessons

In any teaching program the first step is to familiarise children with the keyboard. The spelling lesson begins with an apparently easy exercise—write the alphabet.

A second exercise involves the placing of prefixes and includes an element of reinforcement when the student is asked to select definitions for the words he or she has just constructed. In all these programs, if a student makes more than a certain number of mistakes, he or she is told by the computer to return to teacher.

As a result of using the computer, children accept that they must spell correctly—unlike a teacher, the machine does not understand approximations.

The teaching programs have already interested publishers but the staff involved express the need for more time.

The third function of the school computer is to help with administration. The school houses a branch of Barclays Bank—accounts are handled by the computer. Course options and form lists are already computerised and it is intended to have all the school roll on the computer.

A student is writing a program for the deputy head which will cope with the time-table—listing staff, classes, and rooms.

Pictures by Longfield sixth-former David Whitehead.



# Basic program to operate interface

by ROLAND PERRY

LAST MONTH we looked at the hardware interface required to convert IBM Selectric typewriters into computer terminals and the principles behind the conversion. Part II describes a program in Basic (fig A) which accepts data in ASCII form, and operates the parallel interface to the Selectric driver electronics.

FIRSTLY, a code conversion is performed, using a look-up table and then the protocol of the handshake interface is followed. The Basic is fully commented, and the reader should follow it through for both a golf-ball and a non-golf-ball operation. Subroutine 20000 is called only once to set-up the look-up table, whereas subroutine 10000 outputs each string.

Note the carriage return code added to the string in line 20. As was mentioned in Part I, the Basic is given only to describe the program structure required, as it will run at only a few characters per second, causing both a slow print speed and an unnecessary amount of wear on the printer mechanism.

The subroutine should be converted in machine code for the computer hosting the terminal, and an example (fig B) is given for the Micropolis operating system running in a 32K 8080

The circuit diagram (figure II) printed last month was incomplete. The amended version, along with the power supply for easy reference is printed below.

microprocessor. Before running the driver routines the statement "MEMEND 16R7E7F" must be used to protect the upper section of memory from the Basic User space, otherwise a large program might over-write the drivers. The look-up table occupies 7E80-7EFF and the program 7F00-7F68, plus a few overlays for the existing MDOS printer routines.

Next month: modifications to the system for use as an input device.

Figure A. The BASIC.

```

READY
LIST
10 GOSUB 20000
20 C$="THIS IS A TEST MESSAGE "+CHR$(16R0D)
30 GOSUB 10000
40 END
50 '
60 '
10000 ! THE SUBROUTINE CONVERTS ASCII VALUES FROM THE STRING C$
10010 ! INTO IBM CODES; DIFFERENTIATING BETWEEN GOLFBALL AND
10020 ! NON-GOLFBALL CHARACTERS. A SHIFT OPERATION IS PERFORMED
10030 ! IF REQUIRED.
10040 !
10050 ! PORT 54 HEX (DESIGNATED 16R54 IN MICROPOLIS BASIC) IS THE
10060 ! PARALLEL I/O PORT USED. BIT 7 OF THE OUTPUT (DECIMAL 255)
10070 ! SIGNALS THE HANDSHAKE AND TYPE OF PRINT CYCLE. BIT 7 OF THE
10080 ! INPUT GIVES THE CASE OF THE PRINTER - UPPER OR LOWER - AND
10090 ! BIT 0 OF THE INPUT WHEN ZERO INDICATES THAT THE PRINTER IS
10100 ! BUSY.
10110 !
10120 ! THE MICROPOLIS BASIC FUNCTION "FRAC" RETURNS THE FRACTIONAL
10130 ! PART OF A DIVISION; IE THE REMAINDER ; AND WOULD BE REPLACED
10140 ! BY A SHIFT-RIGHT-INTO-CARRY IN A MACHINE CODE PROGRAM.
10150 !
10160 !
10170 C9=ASC(MID$(C$,X9,1))          !! SELECT X9 TH. CHARACTER
10180 IF C9<16R21 THEN 10480          !! JUMP IF NON-PRINTABLE CHARACTER
10190                                !!
10200                                !! HERE IF PRINTABLE CHARACTER
10210                                !!
10220 C8=C(C9)                        !! LOOK UP IBM CODE IN TABLE
    
```

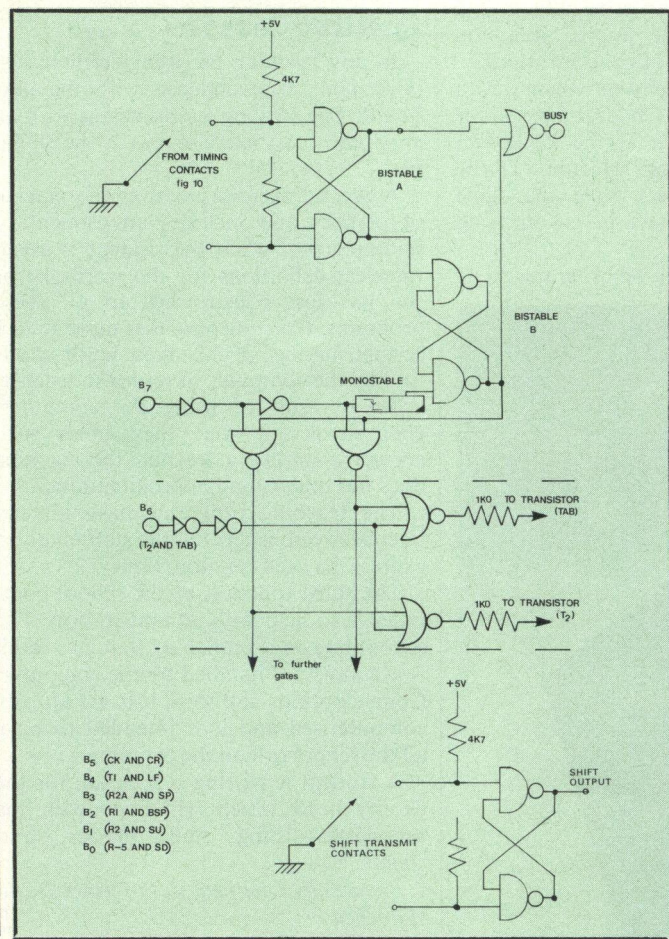

Power supply.

(continued on next page)

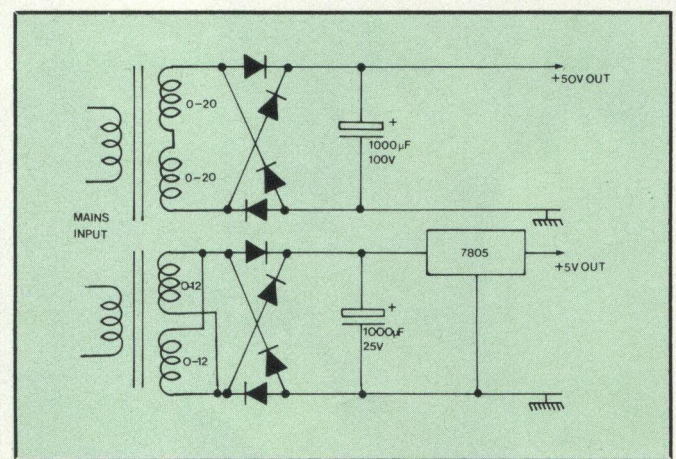

Figure II

(continued from previous page)

<pre> 10230 IF C8=0 THEN 10450 10240 IF C8&gt;127 THEN C8=C8-128:GOTO 10330 10250 10260 IF IN(16R54)&lt;128 THEN 10400 10270 10280 IF FRAC(IN(16R54)/2)=0 THEN 10290 10290 OUT(16R54)=255 10300 OUT(16R54)=127 10310 OUT(16R54)=254 10320 GOTO 10400 10330 10340 IF IN(16R54)&gt;127 THEN 10400 10350 IF FRAC(IN(16R54)/2)=0 THEN 10350 10360 OUT(16R54)=255 10370 OUT(16R54)=127 10380 OUT(16R54)=253 10390 10400 10410 10420 IF FRAC(IN(16R54)/2)=0 THEN 10400 10430 OUT(16R54)=255 10440 OUT(16R54)=127-C8 10450 NEXT X9 10460 RETURN 10470 10480 10490 IF C(C9)=0 THEN 10540 10500 IF FRAC(IN(16R54)/2)=0 THEN 10500 10510 OUT(16R54)=255 10520 OUT(16R54)=127 10530 OUT(16R54)=255-C(C9) 10540 NEXT X9 10550 RETURN 20000 ! THE SUBROUTINE SETS UP THE LOOKUP-TABLE OF CONVERSION CODES 20010 ! WITH VALUES IN HEX FOR EASE OF INTERPRETATION. 20020 ! 20030 DIM C(127) 20040 ! 20050 ! ASCII 1 TO 7 20060 DATA 16R00,16R00,16R00,16R00,16R00,16R00,16R00,16R00 20070 ! 20080 ! ASCII 8 TO 127 20090 DATA 16R04,16R40,16R10,16R00,16R00,16R20,16R02,16R01 20100 DATA 16R00,16R00,16R00,16R00,16R00,16R00,16R00,16R00 20110 DATA 16R00,16R00,16R00,16R00,16R00,16R00,16R00,16R00 20120 DATA 16R08,16R8E,16R9C,16RFC,16RD8,16RA5,16RD0,16R1C 20130 DATA 16RF0,16RD4,16RFA,16RFF,16R29,16R20,16R1A,16REB 20140 DATA 16R54,16R7F,16R7A,16R58,16R75,16R7C,16R58,16R5D 20150 DATA 16R79,16R70,16R8D,16R0D,16R00,16R2A,16R0B,16RAA 20160 DATA 16RF5,16R99,16RC0,16RC9,16RED,16RCC,16R8B,16RAF 20170 DATA 16RE4,16R8E,16R8E,16R8E,16RC5,16R9F,16RCA,16R95 20180 DATA 16RAC,16R88,16R8D,16RB4,16REE,16REB,16R8B,16R90 20190 DATA 16RCF,16R84,16RDE,16R00,16R00,16R00,16R00,16R00 20200 DATA 16R75,16R19,16R40,16R49,16RED,16R4C,16R0B,16R2F 20210 DATA 16R64,16R38,16R0E,16R68,16R45,16R1F,16R4A,16R15 20220 DATA 16R2C,16R08,16R3D,16R34,16R6E,16R6B,16R3B,16R10 20230 DATA 16R4F,16R04,16R5E,16R00,16R00,16R00,16R00,16R00 20240 ! 20250 FOR N= 1 TO 127 20260 READ C(N) 20270 NEXT N 20280 ! 20290 OUT(16R54)=255 !! INITIALISE PRINTER 20300 OUT(16R54)=127 20310 OUT(16R54)=222 20320 ! 20330 RETURN READY </pre>	<pre> 7ECB E8 C5 9F 7ECE CA 95 7ED0 AC 88 8D 7ED2 B4 EE EB 7ED6 88 90 7ED8 CF 84 DE 7EDB 00 00 00 7EDE 00 00 7EE0 75 19 40 7EE3 49 6D 4C 7EE6 08 2F 7EE8 64 38 0E 7EEB 68 45 1F 7EEE 4A 15 7EF0 20 08 3D 7EF3 34 6E 6B 7EF6 3B 18 7EF8 4F 04 5E 7EFB 00 00 00 7EFE 00 00 7F00 7F00 7F00 CD 53 7F 7F03 05 7F04 78 7F05 C6 80 7F07 5F 7F08 16 7E 7F0A 1A 7F0B EE 00 7F0C 0A 51 7F 7F10 57 7F11 78 7F12 FE 21 7F14 FA 4D 7F 7F17 7F17 7A 7F18 FE 80 7F1A F2 2F 7F 7F1D 7F1D DB 54 7F1F E6 80 7F21 CA 41 7F 7F24 06 01 7F26 CD 58 7F 7F29 CD 53 7F 7F2C C3 41 7F 7F2F 7F2F DE 80 7F31 57 7F32 DB 54 7F34 E6 80 7F36 C2 41 7F 7F39 06 02 7F3B CD 58 7F 7F3E CD 53 7F 7F41 3E FF 7F43 D3 54 7F45 7A 7F46 EE 7F 7F48 D3 54 7F4A C3 51 7F 7F4D 42 7F4E CD 58 7F 7F51 D1 7F52 C9 7F53 DB 54 7F55 E6 01 7F57 CA 53 7F 7F5A C9 7F5B 3E FF 7F5D D3 54 7F5F 3E 7F 7F61 D3 54 7F63 78 7F64 EE FF 7F66 D3 54 7F68 C9 7F69 7F69 06CB 06CB C3 00 7F 06CE 06CE 06FE 06 00 0700 CD 03 7F 0703 06 0F 0705 CD 03 7F 0708 06 0E 070A CD 03 7F 070D 06 0F 070F CD 03 7F 0712 AF 0713 C9 0714 0714 06E8 06E8 AF 06E9 C9 06EA 06EA </pre>	<pre> DB 0ACH, 88H, 08DH, 0B4H, 0EEH, 0EEH, 0BBH, 90H DB 0CFH, 84H, 0DEH, 00H, 00H, 00H, 00H, 0A0H DB 75H, 19H, 40H, 49H, 6DH, 4CH, 0BH, 2FH DB 64H, 38H, 0EH, 68H, 45H, 1FH, 4AH, 15H DB 2CH, 08H, 3DH, 34H, 6EH, 6BH, 3BH, 10H DB 4FH, 04H, 5EH, 00H, 00H, 00H, 00H, 00H * ORG 7F00H CALL BUSY ; TEST M/C FINISHED LAST CYCLE PUSH D ; SAVE O/E REGISTER MOV A,B ; ASCII TO A ADI 80H ; FORM LS BYTE OF LU TABLE MOV E,A ; ADDRESS IN E (ASCII+80 H) MVI D,7EH ; MS BYTE OF ADDRESS TO D LDAX D ; GET IBM CODE INTO A XRI 00H ; DUMMY TO SET CONDITIONS JZ END ; ZERO IBM CODE SIGNIFIES NO-OP MOV D,A ; SAVE IBM CODE IN D MOV A,B ; ASCII TO A CPI 21H JM OPCYCLE ; IS IT AN OPERATIONAL CYCLE * THIS ROUTINE OUTPUTS A PRINT CYCLE MOV A,D ; RETURN IBM CODE FROM D CPI 80H ; GREATER THAN 80H SIGNIFIES UPPER CASE JP UPPERCASE * HERE IF LOWERCASE PRINT REQUIRED IN 54H ; TEST CASE BIT ANI 80H ; JZ PRINT ; ZERO INDICATES M/C IN LC MVI B,01H ; IBM CODE FOR SHIFT DOWN CALL OPPRINT ; WAIT FOR END OF OPERATION JMP PRINT *HERE IF UPPERCASE PRINT REQUIRED UPPERCASE SBI 80H ; REMOVE MSB FROM IBM CODE MOV D,A ; REPLACE IBM CODE IN D IN 54H ; TEST CASE BIT ANI 80H ; JNZ PRINT ; 1 INDICATES M/C IN U.C MVI B,02H ; IBM CODE FOR SHIFT UP CALL OPPRINT ; WAIT FOR END OF OPERATION CALL BUSY ; RAISE STROBE LINE MVI A,0FFH ; OUT 54H ; IBM CODE TO A MOV A,D ; COMPLEMENT XRI 7FH ; IBM CODE, BIT 7=0 OUT 54H ; WHICH LOWERS STROBE LINE JMP END OPCYCLE MOV B,D ; IBM CODE TO B CALL OPPRINT END POP D BUSY RET IN 54H ; TEST BIT 1 ANI 01H ; JZ BUSY RET UPPRINT MVI A,0FFH ; RAISE STROBE LINE OUT 54H ; MVI A,7FH ; LOWER STROBE LINE OUT 54H ; MOV A,B ; IBM CODE TO A XRI 0FFH ; COMPLEMENT IBM CODE, BIT 7=1 OUT 54H ; RET * ORG 06CBH *THIS ROUTINE WILL OVERLAY LDOUT JMP IBMOUT * ORG 06FEH *THIS ROUTINE WILL OVERLAY LDINIT MVI B,0DH ; CARRIAGE RETURN CALL 7F03H ; DO AN OUTPUT MVI B,0FH ; SHIFT DOWN CALL 7F03H ; MVI B,0EH ; SHIFT UP CALL 7F03H ; MVI B,0FH ; SHIFT DOWN CALL 7F03H ; XRA A RET * ORG 06E8H *THIS ROUTINE WILL OVERLAY LDATN XRA A RET * END @WARMSTART; JUMP TO WARMSTART MDO5, INITIALISE I/O </pre>
--	--	---

Figure B. The 8080 machine code.

<pre> 0000 0000 0000 7E80 00 00 00 7E83 00 00 00 7E86 00 00 7E88 04 40 00 7E8B 00 00 20 7E8E 02 01 7E90 00 00 00 7E93 00 00 00 7E96 00 00 7E98 00 00 00 7E9B 00 00 00 7E9E 00 00 7EA0 08 BE 9C 7EA3 FC D8 A5 7EA6 D0 1C 7EA8 F8 D4 FA 7EAB FF 29 20 7EAE 1A EB 7EB0 54 7F 7A 7EB3 58 75 7C 7EB6 58 5D 7EB8 79 70 8D 7EBB 00 00 2A 7EE0 00 00 7EC0 F5 99 C0 7EC3 C9 ED CC 7EC6 8B AF 7EC8 E4 B8 8E </pre>	<pre> LINK * ORG 7E80H DB 00H, 00H, 00H, 00H, 00H, 00H, 00H, 00H DB 04H, 40H, 00H, 00H, 00H, 20H, 02H, 01H DB 00H, 00H, 00H, 00H, 00H, 00H, 00H, 00H DB 00H, 00H, 00H, 00H, 00H, 00H, 00H, 00H DB 08H, 0BEH, 9CH, 0FCH, 0D8H, 0A5H, 0DDH, 1CH DB 0F0H, 0D4H, 0FAH, 0FFH, 29H, 20H, 1AH, 0EBH DB 54H, 7FH, 7AH, 5BH, 75H, 7CH, 58H, 5DH DB 79H, 70H, 8DH, 0DH, 00H, 2AH, 00H, 0AAH DB 0F5H, 99H, 0C0H, 0C9H, 0EDH, 0CCH, 8BH, 0AFH DB 0E4H, 0B8H, 8EH, 0E8H, 0C5H, 9FH, 0CAH, 95H </pre>
--	---

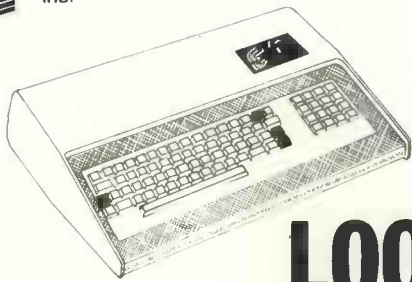

Introducing the personal  
computer you've waited for.

The Exidy Sorcerer.

**LOOK AT THESE FEATURES**

16K £760  
32K £859  
add 8%  
VAT

The Sorcerer Computer is a completely assembled and tested computer system ready to plug in and use. The standard configuration includes 63 key typewriter-style keyboard and 16 key numeric pad dual cassette I/O, with remote computer control at 300 and 1200 baud data rates, RS232 serial I/O for communication, parallel port for direct Centronics printer attachment, Z80 processor, 4K ROM operating system, 8K Microsoft BASIC in separate plug-in Rom Pac™ cartridge, composite video of 64 chars x 30 lines, 128 upper/lower case ASCII character set and a 128 user-defined graphic symbols, up to 32K on-board RAM memory, operators manual, BASIC programming manual and cassette/video cables, connection for S100 bus expansion unit giving access to the spectrum of exciting and useful peripheral devices, such as Floppy disk drives, voice recognition/synthesis battery back-up board in case of power failure, additional memory boards, E-PROM cards give you the facility to program and re-program your own ROM memories etc. etc. This is the most useable and flexible system that's now available to the home and business user at such a low price.

- \* WORD PROCESSING, COBAL, FORTRAN etc
- \* PLUG IN ROM CARTRIDGES
- \* WORKS WITH NORMAL TV
- \* S100 EXPANSION UNIT
- \* CASSETTE INTERFACE
- \* Z80 CPU
- \* 32K RAM ON BOARD
- \* A REAL BUSINESS MACHINE

SEND 50p  
FOR LATEST  
**JADE**  
CATALOGUE  
(UK version)  
contains an  
introduction to  
Microcomputers  
etc.

please make cheques and postal orders payable to JADE  
phone your order quoting ACCESS or VISA number  
for technical information or advice phone 0736 66565

Supplied by - Factor One Computers

**JADE**

17 Market Place, Penzance, Cornwall.

● Circle No. 142

# DE BOER ELECTRONICS

Our program contains a large assortment of kits. Specially interesting is a microprocessor kit designed by Elektor magazine. This SC/MP µP (National Semiconductors) consist of:

- RAM I.O (9846-1), digital in- and output. With binary switches-displaying the databus £32.35
  - SC/MP board (9846-2), a simple mainboard. With the µP- and timing circuits £26.75
- With these two kits you can start your own "µP-ing"
- CPU-card (9851) extension card for the SC/MP. This card contains the SC/MP (you don't need the SC/MP board anymore) E-prom for monitor, some RAM etc. £90.50
  - Bus-board (9857): Handy card to connect to SC/MP unit in an easy way £3.00

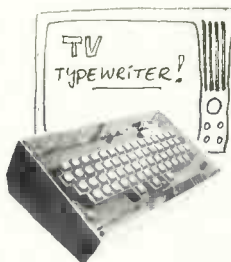

- Memory card (9863): This card completes the heart of the kit. With some memory and monitor E-proms £57.00
- Hex I.O (9893): Now you can load your program in hex-code and on the card there are hex displays £67.25
- 4-K RAM (9885): memory extension £112.05
- SC/MP power supply (9906) with transformers £23.05
- Cassette interface (9905): This kit makes it possible to store programs in an easy way. You can use an ordinary cassette-recorder £16.05
- 3 Elburg-programmed Eproms £68.85  
Complete system, consists of 9851-9863-9885-9906-9905 and Elburg Eproms £349.00
- Keyboard complete with encoder £46.50
- Video display terminal (accepts information of keyboard and SC/MP µP) £69.00

#### Ordering details:

By letter to: Mike Hutchinson, 2 Lynn Road, Grimston, Kings Lynn, Norfolk PE32 1AD. Phone: Monday to Friday 1 pm to 6 pm. Saturday 10 am to 1pm. At Hillingdon (04856) 553 cheques and postal orders only in the name of De Boer Electronics. All prices are VAT-inclusive. Add 50p for post and packing. No callers, please.



**de boer  
elektronika**

Kleine Berg 39-41 Eindhoven  
Nederland, tel 040-448229

● Circle No. 143

WITH so many varied activities in a university city, operating a computer shop demands versatility. Cambridge Computer Store provides it for a broad spread of customers.

# All this and a farm feed program, too

IN Emmanuel Street, Cambridge, not far from King's College and its impressive chapel, there is a small computer shop owned by Claude Cowan, which may seem a trifle out of place.

"On the contrary, it's natural to be here", says Cowan. "Being outside London has not affected business at all; as a matter of fact, we are doing extremely well. In Cambridge we have some of the finest physics and maths laboratories in the world. The university also has a computer laboratory where extensive software and hardware development is taking place. Cambridge is a fertile area for computing activity, and I could not consider being anywhere else!"

So be it. Cowan obviously must be sure of himself. His background stretches from university days when he graduated in electronics. Since then, he has worked as a systems engineer with extensive involvement in VDUs and now runs his shop while, at the same time, acting as a computer consultant.

How did he become involved with microcomputers? "I was thrown into it", he says.

His shop, before it became Cambridge Computer Store, started as a modest Tandy electronics outlet in November, 1975. It sold assorted audio hi-fi equipment, calculators, hobbyist electronic kits and a selection of electronic components, such as resistors, transistors and capacitors.

## Gradual expansion

The shop expanded gradually, offering a wider range of electronic equipment, and microcomputers followed. Soon afterwards, a separate department evolved within the Tandy store until it changed its name.

"It all happened rather suddenly", says Cowan. "What many people do not realise is that even though micros are just breaking the ice in this country, computing has been going on for a long time. There has been a large amount of research devoted to the subject and a

great deal of it is taking place right here—in Cambridge."

One would tend to think that being in the "centre ring" of computer activity demands certain exceptional qualifications. Cowan feels he has them. He stresses the importance of being able to offer the customer what he calls "a professional level of support."

"When someone enters the shop, whether a beginner, businessman, student, hobbyist or professional, we want him to feel comfortable. Our shop is small. We carry three systems—Apple II, Tandy TRS-80 and North Star Horizon—but we find each system to be an excellent choice for a particular market. The Apple II is an excellent machine for educational purposes, while the North Star system acts as a powerful business machine.

## Tandy is favourite

"The Tandy TRS-80 is our favourite and works well in education, business, home use and recently in farming, for which we have developed a software program, Farm Rationing."

Cowan has written a program which determines proper rations of feed for dairy cattle. It has two parts. The first is Ration Formulation which allows the operator to prepare a trial ration. He does this by selecting 13 ingredients, like wheat, corn, barley and maize from a possible 25 to make up a particular ration of feed for his cattle. When he has chosen the ingredients and decided he has enough for a trial ration, he enters the cost of each ingredient, as well as the amount and the formulation program, and begins to produce a trial ration analysis.

The analysis shows the operator the resulting chemical percentage composition, the energy content and the cost of the trial ration. The results are displayed instantly on the screen and if this is not the optimised ration—not enough energy or too high a cost—the operator can alter the mixture until he has the desired ration. When he is satisfied, the program calculates the mixture and cost of the

ration, and displays the results on the screen.

The second part is the budget forecast which prepares a schedule of ingredient requirements which will be needed over a six-month period. It can cover a herd of cattle and divide the herd into groups. Each group may require a different ration, since groups of cattle calve at different times.

In turn, each group goes through a cycle of rations. The program can also account for ration changes which may no longer be optimum in any particular group.

The program takes all information week by week for each particular group and works out the weekly requirement of each ingredient and also the total requirement over a six-month period.

This is an excellent example of the full use of a micro system such as the Tandy TRS-80 video screen. The file storage capability of the machine is used for recording chemical cost and energy content and its high-speed processing power carries-out ingredient analysis using three-dimensional array multiplication.

## More development

Farm rationing requires a tremendous amount of computation. By more usual means, it would take at least a day or two. Using the micro program it is completed in five or six minutes. The program is in use and working effectively at Attleborough Dairy Farms in Norfolk.

Cowan speaks highly of the Tandy TRS-80. He sees it as a "fine piece of design with excellent, serious application use."

The shop plans to do more software development and has already added a full-time programmer to the staff to work on the Tandy and the Apple II.

Anyone is welcome to visit the shop for hands-on experience. It offers a variety of interesting demonstrations with a good selection of books and magazines, and most important of all, has professional experience. ■

WE LOOK at an idea this month for a game called Warlock Warren and detail an approach to setting it up on your system.

# Warlock Warren

by T. J. Radford

"SOMEWHERE nearby is Colossal Cave, where others have found fortunes in treasure and gold, though it is said that some who enter are never seen again. Magic is said to work in the cave. I will be your eyes and hands. Direct me with commands of one or two words.

"I know of places, actions and things. Most of my vocabulary describes places and is used to move you there. To move, try words like forest, building, downstream, enter, East, West, North, South, up, or down. I know about a few special objects hidden in the cave. These objects can be manipulated using some of the action words that I know.

"The objects have side effects, for instance, the rod scares the bird. Usually people having trouble moving just need to try a few more words. Usually people trying unsuccessfully to manipulate an object are attempting something beyond their capabilities and should try a completely different tack.

"You are standing at the end of a road before a small brick building. Around you is a forest. A small stream flows out of the building and down a gully."

Thus reads the preamble to *Adventure*, a program at present residing on Digital-10 systems all over the country, and a parent of the program here devised for Apple.

## D&D element

Cognoscenti of the games world will recognise an element of Dungeons and Dragons (D&D) in the invitation. Indeed, the lineage of *Warlock Warren* has the fantasy/role-playing class of games at its head.

D&D games have a free format in which players select the character they wish to assume and form an expedition party to seek adventure and treasure in a labyrinth of dungeons. The dungeons are devised by a gamesmaster, who does not do any exploring himself, but instead takes the part of umpire, or god.

In his design, the gamesmaster incorporates various undisclosed rules. During the game he describes to the players the situation in which they find themselves. They then decide what to do, using their imagination to any degree they choose, and he informs them of the outcome of their actions.

The gamesmaster's function includes a

considerable amount of book-keeping and he is usually aided by dice of various "sidedness" and a pocket calculator. D&D has a wide and often fanatical following.

Here our genealogy divides. In one branch of the family, computers are introduced to assume the role of gamesmaster. In the other, standard formats for the description of dungeons, characters and events are used to obviate the need for the gamesmaster entirely.

The first of the branches contains, among others, the game *Adventure*, originating at Stanford Research Institute. As indicated in the preamble to the program, the user is placed near a cave which he must locate and explore. There are hazards to overcome and there is treasure to collect.

## Meeting strangers

The program, like the D&D gamesmaster, describes to the user the situation he is in and he must guess the best action to take. For instance, at one point he is confronted by a snake. If he has caught the bird, encountered earlier, releasing it at this point drives away the snake.

The same ploy, applied to the dragon guarding the Persian carpet, results in the poor bird being reduced to a cinder. The dragon has to be overcome bare-handed.

The other branch of the family includes an interesting games called *Sorcerer's Cave*. Again, the theme is the exploration of a cave. Unlike other games in this category, the cave is not predetermined.

By means of a large pack of "cave cards", the cave grows as it is explored. Each player, in his turn, chooses a direction to explore, takes a cave card from the face-down pack and places it in the chosen position.

A second pack of cards is used to reveal the presence of treasure, artifacts or "strangers", or may imply some random event, such as a cave-in which blocks the retreat.

A complex system of rules governs how strangers may be treated, what treasure may be carried, the use of artifacts and the interaction between players.

The two cognate lines meet again at the program here proposed. Both *Adventure* and *Sorcerer's Cave* can be fascinating

and very distracting. A disadvantage of *Adventure* is that the cave is fixed. Once it has been explored fully and all the points have been gleaned, its interest wanes. All one can do is to try to obtain another program in the same family.

Another disadvantage is that it is strictly solitaire, omitting all element of competition. The *Sorcerer's Cave* format suffers from neither of those deficiencies. The game equipment, however, is somewhat unwieldy. Players find themselves crawling around large areas of floor, trying not to step on the cave cards.

*Warlock Warren* is intended to eliminate those disadvantages, largely using the format of *Sorcerer's Cave*, but applying the computer to the task of manipulating and displaying the game equipment.

## Scenario

The warren is a series of caves created by a warlock as a repository for his ill-gotten gains. There, treasure and potent artifacts are guarded by a variety of creatures, though not all of these are the warlock's minions. Players form separate parties and set out to explore the caves.

In the course of exploration, "strangers" may be encountered, who may choose to join the search party. Each member of the party may carry a certain amount of treasure and any number of artifacts. Points are associated with all beings in the party and all treasure and artifacts. The player to regain the surface with the most points wins.

The program begins by asking for a list of the opponents' names and chosen colours. It allocates randomly the playing order and then asks each player in turn to select the composition of his party. This is done using a "menu", the player entering the numbers which correspond to the beings chosen.

Once the search parties are constituted, the game proper begins. Each player in turn is shown a map of the level on which his party is located, initially the first level. The map displays only that part of the level which has already been discovered and indicates the position of any party on the level, by colour.

Figure 1 shows a portion of such a map. Beneath the map, the lines of text will summarise the status of the current player's party, giving the number of

*continued on next page*

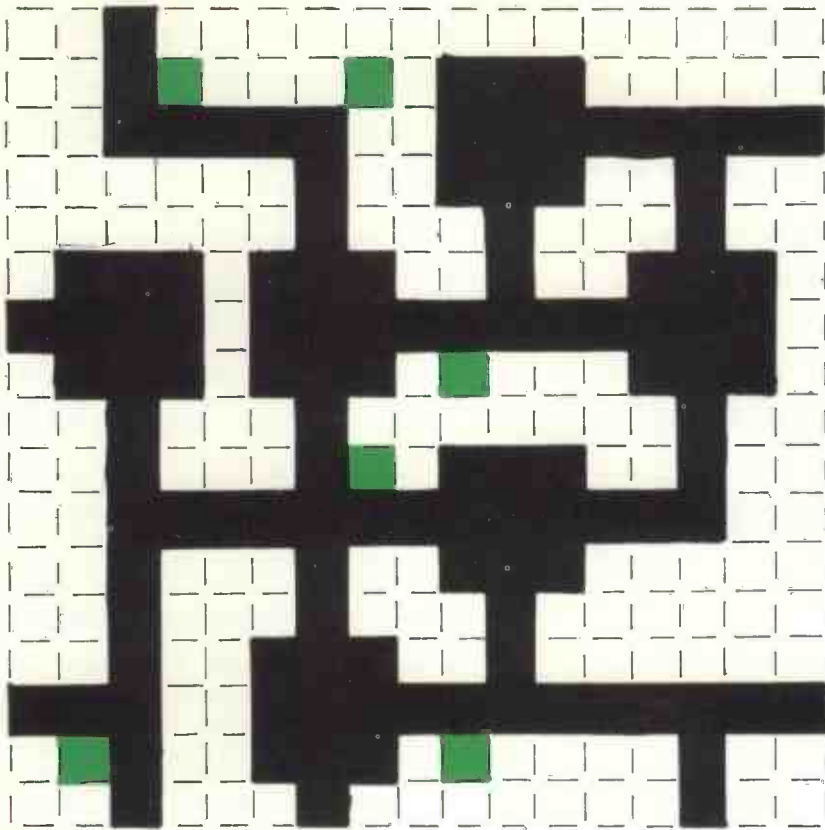

Figure 1

*continued from previous page)*

beings in the party, their total physical strength, magical strength and spare carrying capacity.

There may be up to six exits from the location—North, South, East, West, up or down. The player may indicate the direction in which he wants to move by entering the appropriate initial letter.

**Regular grid**

The warren exists on a regular grid. Grid points can be either caverns or the tunnels which serve to connect caverns. Strangers, treasure and artifacts are found only in caverns and the few random events which may afflict a party can occur only on entry to a cavern.

If the section entered is a cavern, the turn continues. Any random event happens immediately.

Random events are relatively rare and once they are dealt with, a summary of the contents of the cavern is added to the text lines, giving the number of strangers present, their total physical and magical strengths, the probabilities of their being friendly, indifferent or hostile, respectively, the total value and weight of any treasure, and the number of artifacts.

The player may obtain a complete description of everything in the cavern by entering the command MAGNIFY. All commands are entered by initial letter.

The player may elect to GREET any beings encountered. The program determines their reaction based on the probabilities of their being friendly, indifferent or hostile. If they are friendly, they

join the party. If they are indifferent, the turn ends and the player has the same options on his following turn. If they are hostile, combat ensues.

The player may choose to engage the strangers in combat, issuing the ATTACK command. The opposing lines are drawn-up and the program determines the result of the combat. Any strangers surviving the onslaught remain hostile to the party and must be destroyed before any treasure may be taken. They may be attacked again on the following turn.

Certain artifacts may be deployed in combat, although some of them may be used only once during the game, after which their associated points will not be included in the final tally.

The player may choose to RETREAT from a strong group of strangers. This is done on the same turn as he entered the cavern, and the player must leave by the way he went in.

If there are no strangers present, or they have all joined the party or been killed, the CARRY command may be given. Any being in the party with spare

carrying capacity may be assigned treasure and artifacts.

It is anticipated that most of the code will be written in Basic. Some of the details of representation, however, are at bit level and certain routines will thus have to be implemented at machine level. All frequently-performed routine tasks preferably should be written at low level as well.

One such task is the generation of random numbers, which are used to determine warren topology, cavern occupancy and combat results. This will employ a standard modulo-arithmetic, psuedo-random number generator.

The programming of WW breaks-down naturally into six sections. They are concerned with the topology of the warren, random events, the contents of the caverns, combat resolution, various extra commands and overall control.

The representation of the warren must define the connectivity of the cave and permit discrimination between tunnels and caverns. As the cells lie on a regular, three-dimensional grid, the warren can be represented by an array. Each element need indicate only whether or not the cell has yet been opened, and if so, whether the cell is a cavern or a tunnel, and in which directions movement is permitted. This information can be contained in a single byte, as follows.

Bit	Function
7	Area previously explored (bit set).
6	Cavern (set)/Tunnel (clear).
5	North
4	South
3	East
2	West
1	Up
0	Down

} Way open if bit set.

The total size of the warren depends ultimately on the amount of memory available. Another consideration is that certain entities have to contain reference to their location, and it might be desirable to limit the warren size to four levels, each of eight cells by eight. This would permit location information to be contained in a single byte.

For display purposes, each cell will occupy 5 x 5 colour-coded display points. The two kinds of cell are shown in figure 2. Green points represent space and blue points represent rock. Stairs occur only in tunnels and are red points. Their position in the display indicates their direction. The cells in figure 2 have all ways open. Closed ways are depicted as rock, thus the

*(continued on next page)*

Figure 2 Cavern.

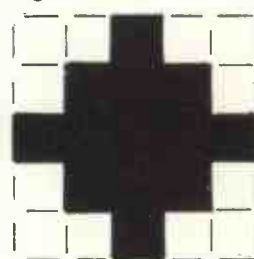

Figure 2 Tunnel.

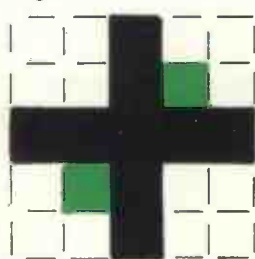
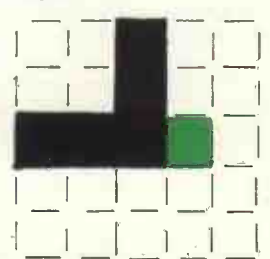

Figure 3



# WHAT CAN YOU BUY

## FOR £99.95 ??

# The Latest Technology A KIM 1 Microcomputer

For:  
Education; Hobbyist, system prototyping, control systems and numerous other applications.

### Ready-to-use

KIM 1 is a complete microcomputer on a single printed circuit module. It comes to you assembled and tested at a price less than many kits. Just connect your power supply (+5V at 1.2A, +12V at 0.1A) and KIM 1 is operational in a matter of minutes.

### The latest technology

KIM 1 is based on the MOS Technology 6502, 8 bit microprocessor array. It has a powerful 56-piece instruction set, 13 addressing modes, multiple interrupts and the ability to address 65K of memory.

The KIM 1 module is provided with two MOS 6530 arrays, each with 1024 bytes of ROM, 64 bytes of RAM, 15 I/O pins and an interval timer. Monitor and operating programs are permanently stored in the 2K of ROM and a separate 1024 byte block of RAM is included for storage of your programs and data.

### Peripheral choice

KIM 1 has a keyboard allowing input of hexadecimal data and seven control codes. With the large, easy to read 6-digit LED display, this allows you to enter programs, read memory contents, execute programs and control system operations.

### A System to grow with:

You can expand your KIM 1 with an 8K Memory Board—the KIM 3B—and a mother board—the KIM 4. KIM 3B £129.95\* KIM 4 £69.95\*

\*Prices do not include VAT at 8%.

### Computerbits Ltd.

41 Vincent St.,  
Yeovil,  
Somerset,  
(Yeovil 26522)

### D.A.M.S. Ltd.

30-36 Dale St.,  
Liverpool 2  
(Liverpool 227 3301)

### G. R. Electronics Ltd.

Farr Oak House  
Church Rd.,  
Newport,  
Gwent  
(Gwent 67426)

### Holdene Ltd

10 Blenheim Terrace,  
Woodhouse Lane,  
Leeds 2  
(Leeds 459 459)

### A. Marshall Ltd

325 Edgware Rd.,  
London W2  
(723 4242)  
also  
85 West Regent St.,  
Glasgow G2 2QD  
(332-4133)

### KIM DEALERS

#### Petalect

33/35 Portugal Rd.,  
Woking,  
Surrey  
(Woking 69032)

### Software Development Services Ltd.

84 Northumberland Rd,  
Ballsbridge,  
Dublin 4,  
Eire  
(683171)

(continued from previous page)

tunnel shown in figure 3 below has only North and West open, and an Up stair.

In the display, the boundary points of the cells can overlap, giving rise to maps such as figure 1. In this way, each cell occupies only  $4 \times 4$  points on the screen, so for display purposes the limit on the size of each level, without "windowing", is  $10 \times 10$  points.

Cells are generated only when this is necessitated by the entry of a party. The open ways of established adjacent cells determine some of the cell bits. The remainder are determined randomly, according to probabilities which will have to be "tuned" by experiment.

The occurrence of a random event implies some non-standard modification of the state of the game. As such, events are best represented by sections of program which perform whatever interactions and modifications are required.

## Two kinds of event

There are two kinds of event. Some have immediate effect only, while others remain latent in the cavern and affect any party to venture that way. For example, a cave-in modifies the cave topology, creating an impassable cell, and is thereafter inactive, although the modification is permanent. A trap, however, remains in the cell in which it occurred, affecting all parties which enter.

When a party enters a new cavern, the program determines whether or not a random event is sprung. The probability is low, but if so, it then determines which event it is. A small array is used to record the location of recurring events. This array is consulted every time a party enters a cavern and the appropriate subroutine is applied whenever indicated.

When a cavern is entered for the first time, its contents are determined. It may be occupied by a collection of creatures, treasure and artifacts. The number of occupants will correspond to the level on which the cavern is located.

The information required about the creatures and objects can be separated into specific information about each one, and general information about classes or types. The specific information needed is the location and state of each entity. The state of an artifact or piece of treasure refers to the creature carrying the object. The state of a creature is a byte carrying the following information:

Bits	Function
7-6	Party in which creature travels.
5	Creature dead.
4	Creature asleep.
3-0	One bit per player: Creature hostile if bit set.

The general information held about each type of creature or object is tabulated:

Creatures	
Name	Identifying string.
Points	Contribution to the final tally.

(continued on next page)



(continued from previous page)

Friendly  
Indifferent  
Hostile  
Strength  
Magic  
Capacity  
Selection

Probability of being friendly.  
Probability of being indifferent.  
Probability of being hostile.  
Normal combat strength.  
Magical strength.  
Weight creature may carry.  
Selection value in initial party composition.

Treasure  
Name  
Points  
Weight

Identifying string.  
Contribution to final tally.  
Load on carrying creature.

Artifacts  
Name  
Points  
Combat  
Greeting  
Shots

Identifying string.  
Contribution to final tally.  
Contribution to combat, if applied.  
Contribution to befriending strangers.  
Number of applications allowed.

Three arrays will hold the general information for creatures, treasure and artifacts respectively. A fourth will hold the specific information for all creatures and objects, in three-byte units. The first of the bytes will indicate the type, referring to an element of one of the arrays, and the others will hold the location and state. Numbers will be limited by memory

considerations to about 85 entities in all.

Combat is resolved in terms of individual strengths. If both sides are of the same size, the opposing creatures are paired and each individual conflict is resolved independently. If one side is larger than the other, some of the skirmishes will be fought two against one.

No more than two creatures may fight a single creature, except that creatures with magical power may wield it from behind the lines, providing that they are not in the front line themselves.

Artifacts may be brought to bear in particular quarrels and some may influence the entire battle, applying to each individual conflict. The total combat points applied in any face-off, augmented by small, random "bonus" points given to each side, are compared. The side with the higher number of points wins and one of their immediate opponents is killed. Each group in the battle is dealt with this way.

When a party engages in combat with a

group of strangers, the strangers should align to their best advantage. To program this kind of requirement is usually awkward and space-consuming.

Other commands may be given at appropriate points, to accomplish certain operations. For instance, it may be desirable to re-distribute the object carried by members of the party. The LUGGAGE command facilitates this. To determine totals at the end of a game, the TALLY command is used, although this will happen automatically once all the players have left the warren.

Certain artifacts have associated commands which accomplish special feats. A magic carpet can FLY the party to any part of the warren, just once. The magic flute will lull certain creatures to sleep. The code associated with such commands will first check that the artifact is carried by a member of the party.

\*T. J. Radford was a runner-up in our Apple competition.

## NASCOM systems from Lock stock

Z80 development from NASCOM microcomputers price £197.50

### Hardware

- Powerful Z80 Based System
- 2K bytes RAM
- 1K Monitor PROM Expandable
- Audio Cassette interface 25 CPS
- Composite Video Output plus UHF

modulated output for standard

TV-48 characters + 16 lines

- 20mA/RS 232C output
- 28 bit programmable I/O ports
- 48 Character ASCII keyboard
- Expandable system for extra memory and I/O on NASBUS



### Software

- Memory display/modify
- Serial I/O dump/load
- Set break point
- Single step with register display

### Other products available

- Power Supplies
- 4K and 16K memory boards
- Basic Interpreter
- I/O Board
- VERO frame
- NASBUS motherboard



Nascom Microcomputers

Authorised Distributor

Dial



for action!

061-652 0431

01-622 2084/3276

TELEX 669971

Lock Distribution, Neville St., Oldham. OL9 6LF  
A member of the Foseco Minsep Group.

● Circle No. 145

# TWO POWERFUL LOW COST MICROCOMPUTER SYSTEMS

## **1** compelec SERIES I

- Fast 4MHz Z80 CPU.
  - Selectable Disk Capacity (½M, 1M, 2M, or 4M Bytes.)
  - 2 Parallel Ports
  - 2 Serial RS 232 Ports
  - 1 Kilobyte of 2708 EPROM
  - Floating Point Processor
  - 64 Kilobytes of 16K Dynamic RAM
  - Programmable Real Time Clock
- SOFTWARE
- CP/M
  - BASIC
  - COBOL
  - FORTRAN IV
  - PASCAL

## UNDER £5,000

**32K, ½MB disk, serial I/O, parallel I/O.**

**Centronics printer and vdu**

---

## **2** ALTAIR 300 WORDFLOW BUSINESS SYSTEM

- word processing
- multi-user
- multi-tasking
- re-entrant operating system
- 4 + V.D.U. capability + printers
- extensive library of end-user software
- full field service facilities

## from only £15,500



**compelec**  
LONDON BIRMINGHAM STOCKHOLM LOS ANGELES  
14-15 BERNERS STREET, LONDON W1P 3DE

# ILLUSTRATING BASIC

## ( A SIMPLE PROGRAMMING LANGUAGE )

WE CONTINUE our series of articles on how to program in Basic, probably the most widely-used programming language for small computers.

For the series, we have obtained the serialisation rights for one of the best books on the subject, *Illustrating Basic* by Donald Alcock.

★

Each month, we are publishing a part of the book, so by the end of the series you will have the complete book.

It is written with a distinct informality and has a rather unusual presentation; but it is this style, we believe, which makes it one of the most easy to read tutorials.

★

Alcock *Illustrating Basic*. Chapter 2. c Cambridge University Press. Reprinted by permission.

★

Copies of *Illustrating Basic* can be obtained from *Practical Computing*.

## CONTENTS

### PREFACE

- |      |   |    |
|------|---|----|
| 1. C | OMPONENTS OF THE LANGUAGE                 | 2  |
| 2. I | INPUT & OUTPUT, EXPRESSIONS AND FUNCTIONS | 15 |
| 3. C | ONTROL                                    | 39 |

## CHAPTER 3 CONTINUED FROM LAST MONTH...

- |                 |  |    |
|-----------------|--|----|
| FOR / NEXT      | ≈ THE CONTROL OF LOOPS                       | 48 |
| GO SUB / RETURN | ≈ THE CONCEPT OF A SUBROUTINE                | 52 |
| MOO             | ≈ A GAME OF BULLS & COWS ILLUSTRATING GO SUB | 56 |

- |      |                         |     |
|------|-------------------------|-----|
| 4. A | RRAYS                   | 59  |
| 5. M | ATRICES                 | 75  |
| 6. C | OMLETE EXAMPLE PROGRAMS | 101 |
| 7. C | OMMANDS AND SIGNING ON  | 111 |
| 8. F | ILES OF DATA            | 119 |
| 9. S | YNTAX                   | 127 |
| I    | NDX                     | 132 |

# FOR-NEXT

THIS MAKES BASIC OBEY A SEQUENCE OF INSTRUCTIONS AGAIN & AGAIN

WE CALL THIS SEQUENCE A LOOP.

```

10 LET M=3
20 READ X$
30 PRINT M;X$
40 LET M=M-1
50 IF M<>0 THEN 20
60 PRINT "PEAR TREE"
70 DATA "HENS", "DOVES", "PARTRIDGE"
80 END
  
```

RUN

```

3 HENS
2 DOVES
1 PARTRIDGE
PEAR TREE
  
```

YOU CAN CREATE A LOOP BY SETTING A "COUNTER"

( LET M=3 )  
 THEN SUCCESSIVELY DEDUCTING 1  
 ( LET M=M-1 ),  
 TESTING THE REMAINING VALUE

( IF M<>0 ),  
 AND "LOOPING" BACK  
 ( THEN 20 )  
 UNTIL THE COUNTER RUNS OUT.

BUT THE SAME RESULT MAY BE ACHIEVED MORE SIMPLY AS SHOWN HERE ➔

```

10 FOR M = 3 TO 1 STEP -1
20 READ X$
30 PRINT M;X$
40 NEXT M
50 PRINT "PEAR TREE"
60 DATA "HENS", "DOVES", "PARTRIDGE"
70 END
  
```

THE FORM OF THE INSTRUCTION IS :

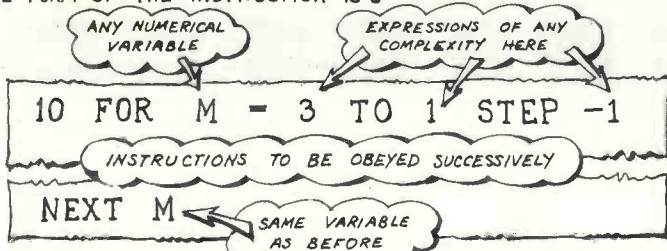

IF THE STEP IS +1 THEN YOU MAY SIMPLIFY BY OMITTING "STEP 1":

```
100 FOR N = P TO Q
```

LOOPS MAY BE NESTED ONE INSIDE THE OTHER.

```

10 PRINT "OLD GLORY (A.D. 1912)"
20 FOR R = 1 TO 7
30 LET P$ = " "
40 IF R=1 THEN 60
50 LET P$ = "*"
60 FOR C = 1 TO 8
70 PRINT P$;
80 NEXT C
90 IF R-2*INT(R/2)=0 THEN 130
100 FOR C = 1 TO 12
110 PRINT "==" ;
120 NEXT C
130 PRINT
140 NEXT R
150 FOR R = 1 TO 3
160 PRINT
170 FOR C = 1 TO 20
180 PRINT "==" ;
190 NEXT C
200 PRINT
210 NEXT R
220 END
  
```

THERE IS ALWAYS SOME LIMIT TO THE PERMISSIBLE DEPTH OF NESTING. A TYPICAL LIMIT IS ABOUT 10 WHICH IS AMPLE DEPTH FOR EVEN THE MOST COMPLICATED PROGRAM.

LOOPS MUST NOT BE INTERLEAVED.

10 FOR I =  
20 FOR K =

60 NEXT I  
70 NEXT K



YOU MAY JUMP OUT OF A LOOP :

† OLDE ENGLISH FOLKE  
SONGE "WIDDICOMBE FAIR"

```

10 REM FIND YOUR PLACE ON THE MARE †
20 DATA "BREWER", "STEWER", "GURNEY"
30 DATA "DAYEY", "WHIDDON", "HAWK"
40 DATA "COBBLEIGH"
50 PRINT "TYPE YOUR LAST NAME"
60 INPUT N$
70 FOR L = 1 TO 7
80 READ M$
90 IF M$ = N$ THEN 130
100 NEXT L
110 PRINT N$; " IS NOT ON THE MARE"
120 GO TO 140
130 PRINT N$; " IS NUMBER"; L
140 END
  
```

THIS IS CALLED  
SCANNING A LIST  
TO FIND A MATCH.

THE LOOPING VARIABLE (L ABOVE) KEEPS ITS VALUE IF YOU JUMP OUT OF A LOOP BEFORE THE LOOP HAS RUN ITS COURSE. BUT IF YOU DROP OUT AT THE BOTTOM (IN THIS CASE TO LINE 110) THEN

**DON'T**

ASSUME ANYTHING ABOUT THE VALUE OF THE LOOPING VARIABLE : IT MIGHT BE 8 ABOVE (THIS IS EXPLAINED OVERLEAF) BUT IT MIGHT NOT. BASICS DIFFER.

# LOOPS (CONTINUED)

YOU SHOULD NEVER JUMP INTO THE MIDDLE OF A LOOP:

```

120 IF A > 2 THEN 210
200 FOR I = 1 TO 6
210 PRINT "*";
220 NEXT I
230 LET A = A - 1
    
```

BASIC WOULD NOT OBEY A "NEXT" IF IT HAD NOT PREVIOUSLY OBEYED THE MATCHING "FOR".

BUT IN MOST BASICS YOU MAY JUMP OUT OF A LOOP AND THEN BACK IN AGAIN (NOT A VERY GOOD PRACTICE).

```

150 FOR I = 1 TO 6
160 READ M$
170 IF M$ = N$ THEN 300
180 NEXT I
300 PRINT M$
310 GO TO 180
    
```

THE JARGON FOR THIS IS A LOOP WITH EXTENDED RANGE.

IN GENERAL YOU SHOULD ENTER A LOOP THROUGH ITS "FOR" STATEMENT AND EITHER:

- FALL THROUGH AT THE "NEXT", OR
- JUMP OUT AND STAY OUT.

IF YOU NEED EXTENDED RANGE THEN ACHIEVE IT USING THE "GO SUB" INSTRUCTION DESCRIBED ON PAGE 52.

IF A PROGRAM IS NOT SUPPOSED TO EXECUTE A LOOP AT ALL UNDER CERTAIN CONDITIONS THEN IT IS SAFEST TO TEST FOR THOSE CONDITIONS, AND, IF THEY APPLY, TO AVOID THE LOOP ALTOGETHER.

```

10 FOR I = 1 TO 5
20 READ C
30 PRINT C;
40 IF C <= 0 THEN 80
50 FOR R = 1 TO C
60 PRINT "*";
70 NEXT R
80 PRINT
90 NEXT I
100 DATA 3, 0, -1, 4, 1
110 END
    
```

MIS THE LOOP RUNNING FROM 1 TO C WHEN C=0

```

RUN
3 ***
0
-1
4 ****
1 *
    
```

THE REASON FOR THIS PRECAUTION IS GIVEN OPPOSITE.

**A**LTHOUGH THE CONCEPT SEEMS SIMPLE THERE ARE HIDDEN DANGERS WITH LOOPS; DIFFERENT BASICS DEAL WITH THEM DIFFERENTLY. HERE IS THE INTERPRETATION IN MORE THAN ONE STANDARD BASIC.

CONSIDER THIS LOOP:

WHERE A, Z & S COULD BE COMPLICATED EXPRESSIONS

```
10 FOR V = A TO Z STEP S
    BODY
40 NEXT V
```

**T**HE INTERPRETATION INVOLVES 3 VARIABLES WHICH BASIC ITSELF CAN USE BUT WHICH YOU, THE USER, CAN NEITHER REFER TO NOR CHANGE. CALL THEM:

♂ MARS      ♀ VENUS      🐟 FISH

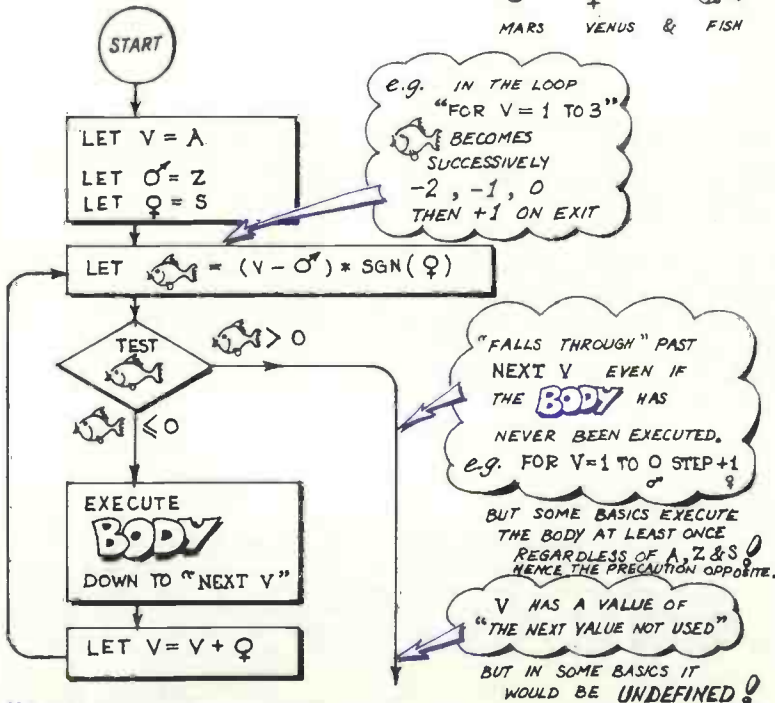

**T**HIS LOGIC IMPLIES NO MATTER WHAT CHANGES YOU MAKE TO A, Z OR S IN THE BODY OF THE LOOP IT WILL NOT AFFECT THE NUMBER OF TIMES ROUND THE LOOP. BUT YOU SHOULD NEVER CHANGE THE VALUE OF V IN THE BODY OF THE LOOP.

REMEMBERING THAT MANY BASICS DON'T USE THIS LOGIC, NEVER CHANGE ANYTHING IN THE BODY THAT COULD ALTER THE VALUE OF V, A, Z OR S. KEEP THE CONTROLS SIMPLE!

# GO SUB - RETURN

IN MANY PROGRAMS A PARTICULAR SEQUENCE OF INSTRUCTIONS OCCURS SEVERAL TIMES. IN SUCH CASES YOU DON'T HAVE TO REPRODUCE THAT SEQUENCE SEVERAL TIMES; YOU MAY PARCEL IT UP AS A SUBROUTINE AND SIMPLY GO TO THAT SUBROUTINE FROM ANY LINE IN THE PROGRAM AND RETURN TO THE PLACE FROM WHENCE YOU CAME.

THE PROGRAM CALLED "OLD GLORY" ON PAGE 49 HAS A SEQUENCE OCCURRING THREE TIMES:

FOR C = 1 TO something  
PRINT something;  
NEXT C

WHICH COULD BE PARCELLED UP AS A SUBROUTINE:

```
300 REM SUBROUTINE WITH B & P$
310 FOR I = 1 TO B
320 PRINT P$;
330 NEXT I
340 RETURN
```

AND THE PROGRAM "OLD GLORY" RE-CAST LIKE THIS:

```
10 PRINT "OLD GLORY WITH GO SUB & RETURN"
20 FOR R = 1 TO 7
30 LET P$ = " "
40 IF R = 1 THEN
50 LET P$ = "*"
70 LET B = 8
80 GO SUB 300
90 IF R - 2 * INT(R/2) = 0 THEN 130
100 LET B = 12
110 LET P$ = "=="
120 GO SUB 300
130 PRINT
140 NEXT R
150 FOR R = 1 TO 3
160 PRINT
170 LET B = 20
180 GO SUB 300
200 PRINT
210 NEXT R
220 GO TO 900
900 END
```

Annotations:

- Line 30: 2 SPACES
- Line 40: 70
- Line 50: 300
- Line 80: GOES TO 300 RETURNS TO 90
- Line 120: RETURNS TO 130
- Line 180: RETURNS TO 200
- Line 220: MISS THE SUBROUTINE
- Line 220: INSERT SUBROUTINE HERE



THE FORM OF THE INSTRUCTION IS:

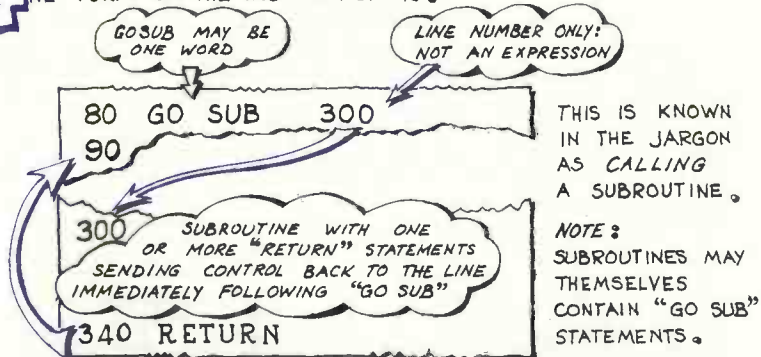

"GO SUB" MAY BE ANYWHERE IN THE PROGRAM; THE SUBROUTINE BEING CALLED MAY ALSO BE ANYWHERE (NOT NECESSARILY ON HIGHER-NUMBERED LINES). YOU NEED CAREFUL ORGANIZATION TO PREVENT AN IMPOSSIBLE TANGLE.

A FEW BASICS ALLOW DUMMY PARAMETERS IN A SUBROUTINE. (THEY WORK IN THE MANNER EXPLAINED ON PAGE 26 IN CONNECTION WITH DUMMY ARGUMENTS OF FUNCTIONS.) HERE AGAIN DETAILS VARY A LOT FROM BASIC TO BASIC AND YOU SHOULDN'T USE DUMMY PARAMETERS IF YOU WANT "PORTABLE" PROGRAMS.

TAKE CARE NOT TO "FALL" INTO A SUBROUTINE BY ACCIDENT. NOTICE LINE 220 OPPOSITE: IF THIS WERE OMITTED THERE WOULD BE SUCH A "FALL".

CONTINUED OVERLEAF.

# GO SUB (CONTINUED)

NOVICES TO PROGRAMMING MAY CARE TO SKIP THIS DOUBLE PAGE THE FIRST TIME THROUGH THE BOOK

"GO SUB" MAY APPEAR ANYWHERE IN A PROGRAM; LIKEWISE THE SUBROUTINE BEING CALLED MAY BE ANYWHERE. BASIC HAS NO SURE WAY OF ASSOCIATING A "RETURN" WITH THE PARTICULAR "GO SUB" OF YOUR INTENTION. (IT'S NOT LIKE "FOR V=" FOLLOWED BY "NEXT V" WHERE THE "V" MAKES THE ASSOCIATION CLEAR.) SO WE DESCRIBE BELOW HOW BASIC IS ABLE TO MAKE SUCH AN ASSOCIATION.

SOME BASICS DEAL WITH "GO SUB" BY A TECHNIQUE CALLED STACKING. THE STACK WORKS LIKE THIS:

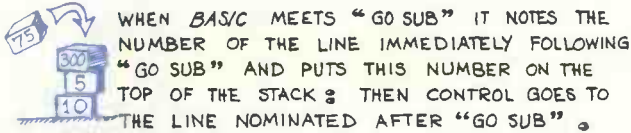

WHEN BASIC MEETS A "RETURN" IT SIMPLY LOOKS AT THE NUMBER CURRENTLY AT THE TOP OF THE STACK; GOES STRAIGHT TO THE LINE HAVING THAT NUMBER; THEN THROWS AWAY THAT NUMBER FROM THE TOP OF THE STACK.



THIS LOGIC IMPLIES THAT IF BASIC MEETS A "RETURN" BEFORE THE VERY FIRST "GO SUB" THEN THERE WILL BE AN EMPTY STACK, HENCE NOWHERE TO GO — OFTEN A BUG IN THE PROGRAM CAUSING CONTROL TO "FALL" INTO A SUBROUTINE. ON THE OTHER HAND BASIC MAY KEEP MEETING "GO SUB" BUT NOT ENOUGH "RETURNS" RESULTING IN THE STACK FILLING TO CAPACITY (WHICH VARIES FROM BASIC TO BASIC BUT IS TYPICALLY 10).

ALTHOUGH NOT ALL BASICS USE THIS PRECISE MECHANISM FOR HANDLING "GO SUB" YOU MAY THINK OF IT THIS WAY WHEN TESTING THE PROPOSED LOGIC OF A PROGRAM YOU ARE GOING TO WRITE, WHEN TRACKING DOWN BUGS IN A PROGRAM, AND WHEN TRYING TO FIGURE OUT THE LOGIC OF SOMEONE ELSE'S PROGRAM.

WHETHER OR NOT YOUR OWN BASIC HANDLES "GO SUB" USING A STACK IS ONLY IMPORTANT IF YOU WRITE A SUBROUTINE THAT CALLS ITSELF. THIS IS KNOWN AS RECURSION AND IS ONLY FEASIBLE WITH THE LOGIC OF THE STACK EXPLAINED ABOVE.



**T**HIS STACK SHOWS THAT THE LAST "GO SUB" TO BE OBEYED IS THE SAME AS THE PREVIOUS ONE  $\Rightarrow$  INDICATING THAT A SUBROUTINE HAS JUST CALLED ITSELF *DIRECTLY*. EARLIER A SUBROUTINE HAD CALLED ANOTHER WHICH, IN TURN, HAD CALLED THE FIRST ONE AS SHOWN BY THE  $\star$  ON THE PICTURE. THUS A SUBROUTINE HAD CALLED ITSELF *INDIRECTLY*.

YOU MAY DISCOVER IF YOUR VERSION OF BASIC ALLOWS SUBROUTINES TO CALL THEMSELVES. TRY THE FOLLOWING LITTLE PROGRAM WHICH FINDS THE HIGHEST COMMON FACTOR OF TWO NUMBERS BY EUCLID'S METHOD.

```

10 PRINT "TYPE 2 POSITIVE INTEGERS"
20 INPUT M,N
30 GO SUB 70  $\leftarrow$  CALLS SUBROUTINE
40 PRINT "THEIR H.C.F. IS "; P
50 GO TO 140  $\leftarrow$  STOPS (DOESN'T FALL THRU SUBROUTINE)
60 REM END OF PROGRAM
70 REM START OF SUBROUTINE
80 LET P=N
90 LET N=M-N*INT(M/N)
100 LET M=P
110 IF N=0 THEN 130  $\leftarrow$  RETURNS IF N=0
120 GO SUB 70  $\leftarrow$  CALLS ITSELF IF N $\neq$ 0
130 RETURN
140 END

```

YOUR OWN BASIC MAY WELL SAY THERE ARE NOT ENOUGH "RETURNS"  $\Rightarrow$  IN WHICH CASE IT PROBABLY DOESN'T USE THE LOGIC OF A STACK. (YOU MAY THEN CHANGE LINE 120 TO "GO TO 70" AND IT SHOULD WORK.)

IF YOUR BASIC ACCEPTS THE PROGRAM WITHOUT ANY ALTERATION TO LINE 120 THEN YOU MAY EXPERIMENT TO FIND THE LIMITING HEIGHT OF THE STACK. THUS IF YOU TYPE 85, 204 THE PROGRAM WILL PRINT THE RESULT WHICH IS 17. BUT IF YOU TYPE 85, 289 THEN THE ALLOWABLE STACKING HEIGHT WILL PROBABLY BE EXCEEDED ALTHOUGH THE ANSWER IS STILL 17.

**T**RY "PLAYING COMPUTERS" USING PENCIL, PAPER AND POCKET CALCULATOR. THIS SHOULD REVEAL EUCLID'S METHOD AND ALSO SHOW HOW THE STACK BUILDS UP AND COLLAPSES.

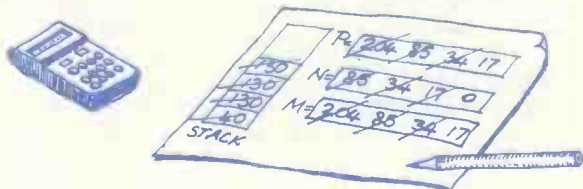

# MOO

THIS IS AN INFURIATING GAME.

THE PROGRAM SHOWN HERE WAS DESIGNED TO PLAY "MOO" AND ILLUSTRATE "GO SUB".

## HOW TO PLAY



START BY THROWING TWO DICE. AS EACH DIE IS CAST TYPE ITS SCORE ON THE KEYBOARD. (THIS MAKES SURE YOU DON'T PLAY THE SAME GAME EVERY TIME.)



THE COMPUTER CHOOSES A NUMBER WITH FOUR DIGITS *NO TWO ALIKE* (NOTE: THE FIRST DIGIT COULD BE ZERO).



YOU GUESS WHAT NUMBER THE COMPUTER HAS CHOSEN AND TYPE YOUR GUESS WHEN INVITED TO DO SO.



THE COMPUTER NOTES HOW MANY OF YOUR DIGITS ARE RIGHT *BUT IN THE WRONG PLACE* EACH OF THESE IT CALLS A COW.



THE COMPUTER NOTES HOW MANY OF YOUR DIGITS ARE NOT ONLY RIGHT *BUT ALSO IN THE RIGHT PLACE* EACH OF THESE IT CALLS A BULL.



HAVING REPORTED YOUR SCORE OF BULLS & COWS THE COMPUTER INVITES YOU TO GUESS AGAIN AND SO ON UNTIL YOU SCORE FOUR BULLS AND NO COWS.

HERE IS THE PROGRAM:

```

5  REM  THE GAME OF MOO
10 PRINT "THROW TWO DICE"
15  INPUT  I,J
20  FOR K = 0 TO 6*I+J-7
25  LET X = RND
30  NEXT K
35  REM  NOW FOR THE PROGRAM PROPER
  
```

POSSIBLY  
RND(C)

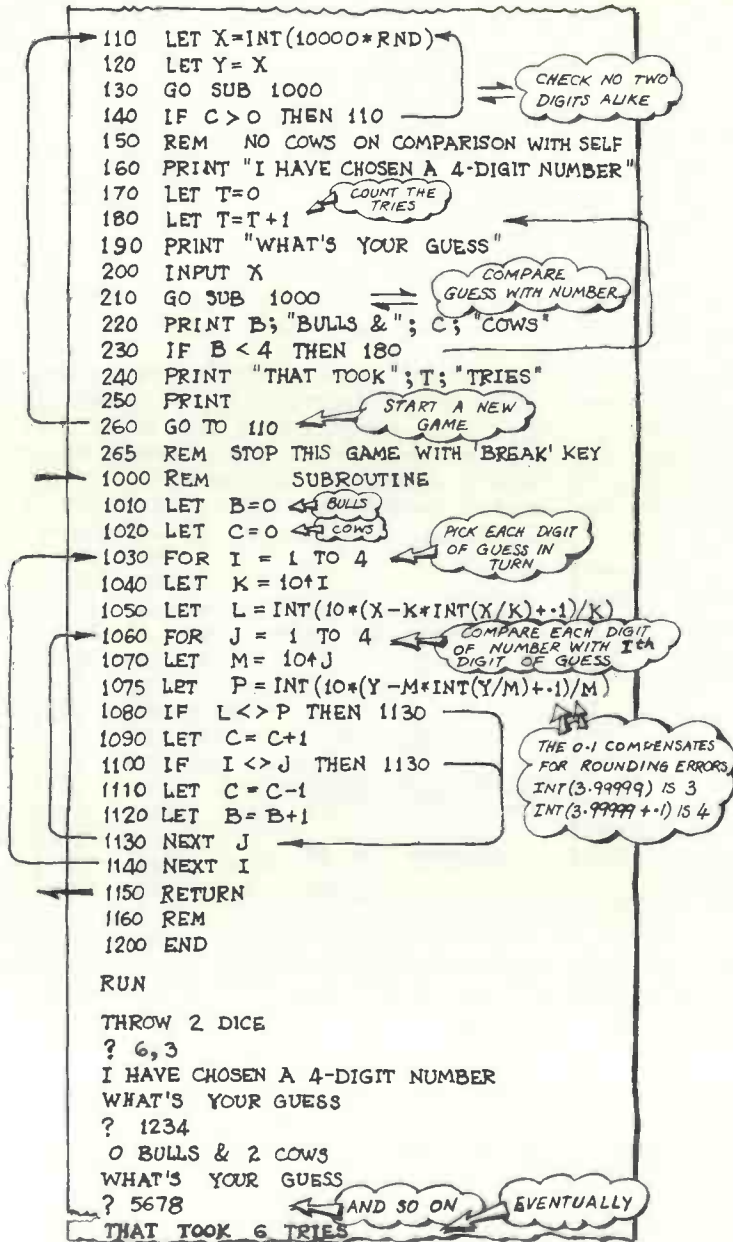



# THE LIMROSE MICROTUTOR 8080

New, Fast and low cost method for learning the "how" of microprocessors

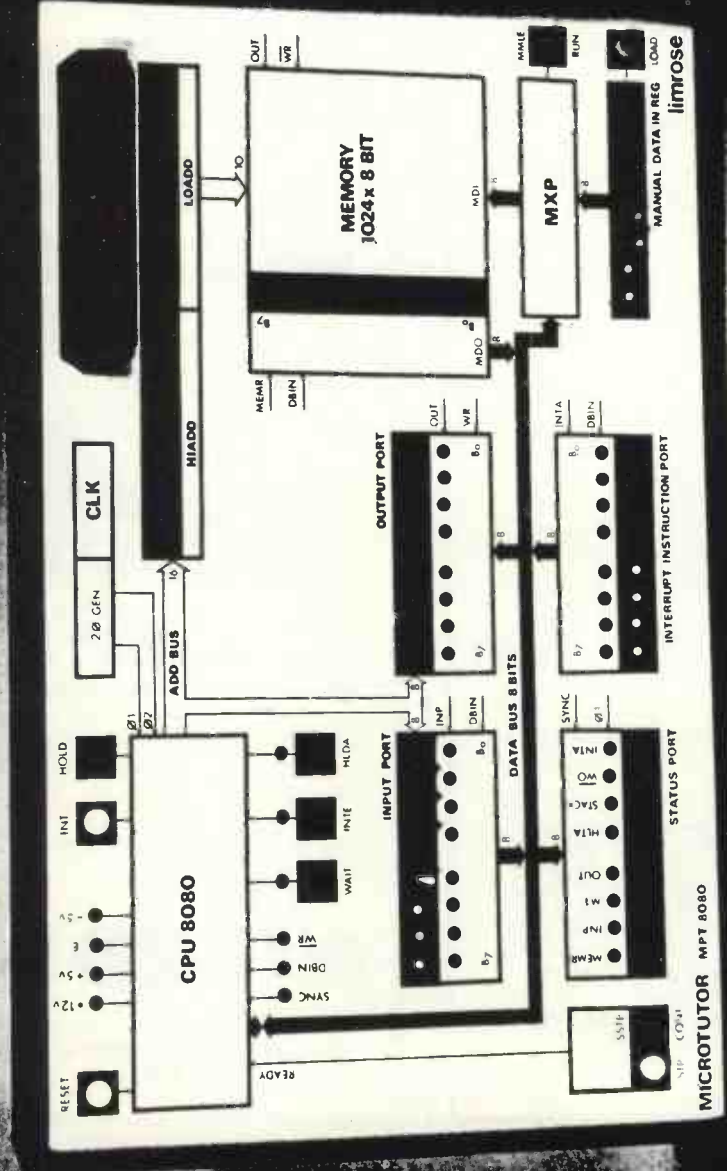

Now... there is a new, fast, simple and inexpensive MICROTUTOR to give you truly "hands on" experience to master and apply microprocessors.

Limrose's MICROTUTOR MPT 8080 has been chosen by the British Post Office, and many other large companies in U.K. and overseas, to train their engineers in this new and exciting technology.

The MICROTUTOR MPT 8080 comes ready to use. Nothing else to buy or debug. It's front panel has all you need to understand how the industry-standard 8080 microprocessor works. And... you can expand it later to use as a 'Development System'.

It's inexpensive, it's versatile and comprehensive.

It has a full range of expansion modules, such as expansion motherboard, RAM, ROM, Teletype and VDU interfaces, Cassette Interface, EPROM and PROM Programmers, and even an inexpensive EPROM erasure.

And, of course, the MICROTUTOR MPT 8080 is supplied with a comprehensive Instruction Book. By following the Instruction Book, most persons with limited technical knowledge can rapidly learn how microprocessors work.

AND... IT IS BRITISH - MADE !!

- \* 8-bit Microcomputer with 1K RAM
- \* 8-bit Input Port
- \* 8-bit Output Port
- \* 8-bit Status Port
- \* Manual or Teletype Operation.
- \* Full vectored- Interrupts
- \* Buffered Data and Address Buses
- \* Advanced "Real-time" monitor
- \* Expandable with plug-in cards
- \* Comprehensive Instruction Book

**limrose electronics limited**  
 241-243 Manchester Road, Northwich, Ches., CW9 7NE. Tel. 0606 41696/7

# The 1979 Micro- Computer Show

(incorporating the DIY  
Computer Fair)

A three day exhibition, with seminars, developed from the highly successful 1978 DIY Computer Show, giving greater emphasis to the rapidly expanding area of Personal Computers in Business.

**Book Now – Save 20%**  
*A discount of 20% is offered on all exhibition space for which full payment is received before 28 FEBRUARY 1979.*

This year exhibitors will be able to sell their goods direct from their stands; creating an ideal market place for the ever growing number of personal computer retail outlets.

*For further information write or telephone*

## onTime

Online Conferences  
Cleveland Rd, Uxbridge  
England, UB8 2DD

Phone: (0895) 39262  
Telex: 281173  
Cables: Online Uxbridge

● Circle No. 148

# APPLE II TAKES ROOT IN SCOTLAND

We are now equipped to deal with your computing requirements North of the Border.

Think about it—an Apple II is only a local phone call away.

For your complete system requirements or even just a demonstration contact us now . . . . . and be ahead of the rest.

**GATE MICROSYSTEMS**  
**PITKERRO HOUSE**  
**BALDOVIE TOLL**  
**DUNDEE**  
**TEL: (0332) 74390**

● Circle No. 149

## MICROSOLVE



If you need advice on which Micro-computer to buy **we can help you**. We are specialist's in writing packages and tailor-made software. **Test our medical and sales ledger packages.**

Come and have a demonstration on the APPLE II and the new multi-user, multi-task MICROSTAR 45.

We promise a personal service (H.P. or leasing terms available).

## MICROSOLVE

Microsolve Computer Services Limited, 2nd floor  
125-129 High St, Edgware.  
Telephone: 01-958-4347.

● Circle No. 150



COST-EFFECTIVENESS is possibly of paramount consideration when a microcomputer hobbyist contemplates buying a peripheral bulk-storage device. Mini-floppy diskette is generally too expensive to consider, being extremely costly, even in its cheapest versions, being of as little capacity as 48Kbytes from a 5¼in. disc, compared to as much as 330Kbytes on others of the same size.

In those circumstances it is not surprising that the Philips Compact cassette is chosen most frequently as the bulk program dump-and-store device. It still does not answer the need for a bulk memory store on which the user could maintain files, address large stores of different programs, or address long loops which are uneconomic for being held within the main computers own limited-capacity RAM. This has been an "if only" situation in the minds of users for some time.

All the cassette-recorders I have seen connected to computers have so far been mono machines and have been used exclusively as program-store-and-dump devices. The desire to conform to a standard, a mental block, or sheer tight-fistedness may have caused it to be overlooked that the means of using Compact-cassette bulk-memory have now been with us for some time.

What is proposed is to create an International Forum to raise a new Standard based upon the use of a stereo cassette-recorder, using the outer track of each stereo pair as the store for memory bits and utilising the inner track as an addressable medium of communication with the computer, the tape running at high speed in the search-mode, with the controls set to either FAST FORWARD or FAST REWIND.

When the idea was first conceived some months ago, there was little to be found in suitable hardware to support the system, except at high cost. This is now resolving itself, with much-less-expensive recorders coming into the market. The manager of the TV and audio department of Beatties department store in Solihull, Birmingham, researched the model numbers of machines having either solenoid- or IC-controlled tape functions; some have remote-control facilities through an external connector but all could presumably be adapted easily to our purpose.

Ranging in price from £176 to £420, the models located so far are:—

Technics:	Sony:	Pioneer:
RS-671USD	TCK 6B	CT-F 1000
RS-678US	TCK 7B II	
RS-673	TCK 8B	
RS-M75	TCK 96R	
RS-M85		

There will no doubt be many more of these machines coming into this market where competition is fierce and no-one can afford to ignore new developments.

Using the outer track for program or memory and the inner track for addressing is a system chosen for the desirability of keeping the tracks with most 'traffic'

## Proposal to replace Kansas City Standard

separated, to avoid intermodulation and inter-channel cross-talk; the more protection built into a Standard, the less trouble in the future.

The mode of addressing locations on the inner track which is simplest to organise is to pre-record a timing track throughout the length of the tape. A specific area of memory—ROM or RAM—is devoted to the task of incrementing or decrementing the count along the timing track for any tape in use, with all tapes beginning from their normal start position but being addressable in either direction.

The discrepancy in speed between FAST FORWARD, FAST REWIND and normal RECORD speed results in any audio signal recorded at normal speed

being read at the higher speeds as a higher frequency. Differences between individual machines must also be taken into account, and this is taken care of by a variable-pitch tone-generator which produces two tones in constant relationship with each other throughout their range.

It is proposed that the scale of the variable-pitch control should be graduated in seconds; to use the correct setting it would be necessary for the operator to perform a simple test on a sample C60 cassette.

The cassette is inserted in the recorder at the beginning of a full tape; the time to traverse the whole tape at FAST FORWARD speed is then taken, using a watch with a sweep hand; the time measured then becomes the figure selected on the pitch control for all subsequent tapes of any length, being the setting equivalent to that pitch which, when recorded at 1½ips becomes the correct pair of pitches to be read by the machine when 'listening' to the tape on FAST FORWARD or FAST REWIND.

Total time needed to traverse a complete C60 cassette from end to end varies between roughly 36 and 135 seconds, over a wide range of machinery, requiring an original pair of tones lying between 80 and 300Hz for the lower frequency, and between 135 and 507Hz for the upper.

These would be transformed into tones of 2250 and 3800Hz when being read in the high-speed search mode, these values being the recommended new standard for

the audio equivalents of 0 and 1 in the binary numbering scale.

Neither frequency bears a harmonic relationship to the other, thus allowing a wide-band filter in the 'listening' circuit, without any fear of mutual confusion, and ability to accommodate some considerable tolerance in the precise frequency, either recorded or read.

Cassette access time, when used as bulk storage, is determined by the relative position of the tape, when commanded, and the information location, and will seldom require anywhere near a full traverse, but will be a maximum of the times indicated in the previous paragraph. This is slow, when compared to floppies, but is very tolerable in relation to both price and total storage capacity.

Capacity is the product of baud-rate × 60 seconds × 30 minutes (=one side of the tape). Assuming the speed being used for information transfer as the fastest currently-available system of 2,400 bits per second, this equates to 4,320,000 bits per side—that is 540Kbytes. The cassette used in the system described is thus a 1 Megabyte memory device.

Even allowing 20 percent wastage in program or memory to gaps between blocks of information, plus the space needed for the tape to brake to a standstill, there is still a capacity of 432Kbytes.

Logic and software control of the system may well result in less wastage than this. Use of shorter tapes, such as the available C12 and C15, would often be sufficient and would have creditably short access times for a large range of applications, or for specific blocks of information-retention.

Having expounded the basic architecture of the system, its development would require contributions from a wide range of talents in computing and electronics, so that the logic and operating system may be brought to a standard, and that the interface with bus systems may be designed.

In deference to Kansas City CUTS, we should choose a new location-name and acronym, and I suggest Solihull SLICEM for its place of origin, and a convenient meeting centre, and Stereo Logic in Cassette External Memory, CUTS and SLICEM both being rather sharp titles.

Anyone wishing to comment further, write to the Editor of *Practical Computing*. Bert Martin is 46, an avid writer—of letters, articles, romantic ballads and a first spy novel—and an electronics enthusiast. He picked up the latter interest in the RAF but has spent much of his working life in the furniture industry as a works study engineer and works manager. He is now with the Solihull Area Health Authority. A past secretary of the British Association of Inventors, he arrived at the Promised Land of Computers only in April, 1978 —"since when I cannot stop goggling at every computer book and magazine I can lay my hands on".

COMPANY	SYSTEM	APPLICATION	PRICE RANGE
<b>COMART</b> PO Box 2, St Neots, Cambridgeshire 0480 215005	<b>Microbox</b> , Min. size: Chassis with three sockets. Max. size: Chassis with six sockets.	Aimed mainly at OEM industrial users and perhaps the serious hobbyist. Manufactured in Britain by Comart, it will take Cromemco, North Star and other processors and software.	£70-£195
	<b>Cromemco System Two</b> , Min size: Processor alone with six sockets in kit form. Max size: 21 sockets; 512K of memory; up to three mini-diskettes of 90K bytes each.	Software: Extended Basic; Fortran IV; Cobol; Macro-assembler; Word-processing, DBMS. American system suggested for systems development.	£395 to around £5,000
	<b>Dynabyte</b> , Memory board for any S100 bus system. Available in 16-32K units.		£275-695
	<b>Cromemco System Three</b> , Min size: 32K memory; terminal and printer interface; dual 250K-byte IBM compatible floppy discs. Max size: 128K memory; two-three terminals.	Software: Same as System Two. Suitable for a wide range of commercial and scientific applications. Theoretical maximum of 512K of memory.	£4,174-£10,000-plus
	<b>Horizon</b> , Min size: 16K memory; serial interface; one mini-diskette drive with 90K bytes; power supply. Max size: 48K memory; three diskettes; hardware floating point board.	Software: Extended Basic; disc operating system; monitor; access to CP/M range. Manufactured by North Star Computers of the U.S. Aimed at educational and small business users.	£995-£3,500
	<b>SOL 20/16</b> , Min size: 16K memory; integral keyboard and monitor; serial and parallel interface; cassette unit. Max size: 64K memory; up to 1MB disc capacity.	Software: Extended Basic; Fortran; Focal; Assembler; Editor; Games. Another American system from Processor Technology Corp aimed at the small business and education markets.	£1,785-£5,000-plus
<b>COMMODORE SYSTEMS DIVISION</b> London NW1 01-388 5702	<b>PET</b> , Single unit containing screen, tape cassette and keyboard. Memory is expandable from 8-32K.	Software: Basic; Games; Business packages. The British subsidiary of Commodore Systems of the U.S. sells Pet for home, educational and small business applications. Reviewed in the October issue of <i>Practical Computing</i> ; there are more than 50 dealers throughout the U.K.	From £695
	<b>Kim I</b> , Min size: Processor (6502 chip); small calculator-type keyboard; LED six-digit display; built-in interfaces for audio-cassette and Teletype; 1K RAM; 2K ROM. Max size: Can add: Kim 4 motherboard; Kim 3B 8K RAM (up to 64K); Kim 5 resident assembler.	Software: None available yet, but it has three good manuals. An American import which gives Pet-type capabilities with a maximum configuration. For the hobbyist but used mainly as an evaluation board for the 6502 chip. There are two dealers, GR Electronics and J Marshall, which offer further facilities.	£129-£600 (+VAT)
<b>COMPELEC</b> 107 Kilburn Square, Kilburn High Road, London NW6 01-624 7744	<b>Altair System 1300</b> , Min size: 32K memory; dual minifloppy discs, 71K bytes each formatted; serial interface. Max size: 64K memory; 4 serial ports.	Software: Basic (single and multi-user); Fortran; Cobol. The hardware for the Altair systems is from Pertec in the States, but the software is Anglo-Dutch. For educational and small business systems.	£3,000-£5,500
	<b>Altair System 70</b> , Min size: 33K memory; dual floppy discs, 300K bytes each. Max size: 64K memory; provision for up to 8 VDUs.	Software: Single and multi-user Basic; Fortran; Cobol; APL. Aimed exclusively at business applications; packages are available for general and sales and purchase ledger, payroll, word processing, stock control, estate agency, hotel or small airline reservations, transport management and freight costing. A point-of-sale package will soon be ready.	£4,500 to £10,000-plus
	<b>Altair System 300</b> , Typical size: 64K memory; 10MB disc drive; turnkey processor; VDU; Qume daisywheel printer and disc unit.	Software: Single-user Basic; Fortran; Cobol. The same packages as for the System 70 are available for this top-end-of-the-market-business, orientated system. Compelec has its own office in Birmingham, but a full distributor network is being set up.	£10,000-plus
<b>COMPUTERBITS LTD.</b> 40 Vincent Street, Yeovil, Somerset 0935 26522	<b>System 8</b> , Typical size: 64K memory; 1MB disc storage; serial I/O port for VDU; parallel port to printer; CP/M operating system.	Software: Basic; Pascal; Fortran. This British-manufactured microcomputer system is almost exclusively for business applications.	£3,000-£5,000

(continued on next page)

(continued from previous page)

COMPANY	SYSTEM	APPLICATIONS	PRICE RANGE
<b>COMPUTER MART LTD</b> 38 St Faiths Lane, Norwich. 0603 615089	<b>VDP-80</b> , Typical size: Single desk-top unit housing a 12 in. display, dual standard floppy disc drive, processor, power units, cooling system and fully-programmable keyboard containing 62 alphanumeric, 12 numeric and 12 cursor controls in separate keypads. Normally sold with 32K memory and 1.2M bytes of disc storage but may be expanded.	Software: Included in the price is a sophisticated operating system with Commercial Basic. A range of commercial application packages is available, including word processing if required.	£9,500
<b>COMPUTER WORKSHOP</b> 38 Dover Street, London W1 01-491 7507	<b>System 1</b> , Typical size: 40K memory; dual 8 in. floppy discs, total storage capacity 1.2MB; Ricoh daisywheel printer. <b>System 2</b> , Typical size: 24K memory; dual minifloppy discs of 80K bytes each; Centronics 779 dot matrix printer; VDU. <b>System 3</b> , 12K memory; cassette interface; 40-column dot matrix printer.	Software: Range of Editors, Assemblers, Basics and Games; Information retrieval package. These systems were designed and built in Peterborough and are suitable for educational, small business users and perhaps the more serious hobbyist. There is a large number of dealers around the country.	System 1—£5,000-plus; System 2—around £3,000; System 3—from £1,350
<b>EQUINOX COMPUTER SYSTEMS LTD</b> 32-35 Featherstone Street, London EC1Y 8QX 01-253 3781/9837	<b>Horizon</b> , Min size: 16K memory; Z80A processor; single minifloppy disc drive. Max size: 64K memory, three minifloppy disc drives, any acceptable S100 peripheral boards.  <b>Equinox 300</b> , Min size: 48K memory; dual floppy discs giving 600K bytes of storage; 16-bit Western Digital m.p.u. Max size: Up to 256K memory; up to four 10MB hard discs.	Software: Standard—Basic Interpreter (includes random and sequential access), disc operating system and monitor; Options—Basic Compiler, Fortran, Cobol, and Pilot. The system is suitable for commercial, educational and scientific applications. Application software for general commercial users.  Software: Basic, Lisp, Pascal, Macro Assembler, Text Editor and Processor. All software is bundled. The system is a multi-user, multi-tasking, time-sharing system for 2-12 users. Application software is available for general commercial users.	£1,000—around £2,500  £5,000—£40,000-plus
<b>MICRONICS</b> 1 Station Road, Twickenham, Middlesex 01-892 7044	<b>Micros</b> , Typical size: 1K monitor; 47-key solid state keyboard; interfaces for video, cassette, printer and UHF TV; serial I/Os; dual parallel I/O ports; 2K RAM; power supply.	Software: Extended Basic; Pascal. A British-designed and manufactured system which is being enhanced rapidly. Already available are a 40-column impact printer using plain paper at £360; what is claimed to be the cheapest data terminal around—a system with an acoustic coupler and VDU for £1,020. Prospective applications: small businesses, process controllers and hobbyists.	From £400, assembled

(continued on next page)

The microcomputer for those who need more than the minimum. The right processor for business, scientific and educational use. Proven applications include Games

- Educational • Word Processing • Invoicing • Stock Control
- Sales Ledger • Purchase Ledger • Mailing • Scientific.

### The Horizon computer includes:-

#### Specification

Zilog Z80A MPU • S-100 bus (12 slots) • Solid well-built case • Up to three Shugart mini-floppy disc drives, 90KB each • Serial port for CRT or Teletype • Real-time clock on motherboard • Optional additional serial port and parallel port • Powerful operating system and monitor

- Access to wide range of S-100 special application boards.



# THE NEW HORIZON

#### Languages

Powerful Basic including sequential and random access disc files • formatted output • strings • line editor • machine language CALL • many other facilities. Optional additional software (under CP/M operating system) includes BASIC

compiler, FORTRAN and COBOL.

Horizon Z80A computer with 24K RAM and 1 disc drive £1483.

2 Disc drives £1823 (exclusive of VAT and carriage).



Equinox Computer Systems Ltd,  
32-35 Featherstone Street,  
London EC1Y 8QX.  
Tel: 01-253 3781/9837.

(continued from previous page)

COMPANY	SYSTEM	APPLICATIONS	PRICE RANGE
<b>NASCOM MICROCOMPUTERS</b> 92 Broad Street, Chesham, Buckinghamshire 02405 75151	<b>Nascom I</b> , Min size: CPU; 2K memory parallel I/O; serial data interface; 1K monitor in EPROM. Max size: CPU; 64K memory; up to 16 parallel I/O ports.	Software: Mostly games, but a maths package is on its way. The British-manufactured system started as a hobbyists' package but has found an increasing number of industrial users. Printer and minifloppy interfaces are in preparation. There are about two dozen dealers around the country.	From £197.50
<b>NEWBEAR COMPUTING STORE</b> 7 Bone Lane, Newbury, Berkshire and 2 Gatley Road, Cheadle, Cheshire 0635 49223	<b>Sym 1</b> , Size: 6502 chip and keypad, with memory available in 4K blocks to 64K.	Software: Any Kim software. An American system meant to be the foundation for very small business and hobbyist users.	From £200
	<b>7768</b> , Size: CPU board; 4K memory; cassette and VDU interfaces.	Software: Range of Basics and Games. A British manufactured system for the hobbyists. Expandable to 64K memory, it is available only in kit form.	
	<b>Cromemco Z2</b> , Min size: Z2 chassis: power supply; motherboard; CPU; fan; sockets; Byte saver board; 16K memory. Max size: 48-64K memory; dual 8 in. floppy discs.	Software: Basic, Fortran; Assembler; macro assembler. For small business and educational applications. These systems are also supplied to more than a dozen dealers. Same basic system as Comart.	£1,375 to £4,000
<b>PERSONAL COMPUTERS LTD</b> 18-19 Fish Street Hill, London EC3 01-623 1434	<b>Apple II</b> , Min size: 16K memory; 8K ROM; keyboard; monitors; mini-assembler: colourgraphics; Powell card; RF modulator; Games; Paddles and speaker; 4 demo cassettes. Max size: Expandable to 48K memory, and floppy discs and printers are now available.	Software: Basic; Assembler; Games; Business packages. An American system regarded as suitable for any kind of applications. There are 15 dealers throughout the country and maintenance contracts are offered.	£1,000-£2,000
<b>RAIR</b> 30-32 Neat Street, London WC2 01-836 4663	<b>RAIR Black Box</b> , Min size: 32K memory; dual minifloppy discs, 80K bytes each; two programmable serial I/O interfaces. Max size: 64K memory; 8 serial interfaces; 1MB disc storage (or 10MB hard disc); range of peripherals.	Software: Advanced Basic interpreter, Fortran IV compiler; Cobol compiler. Described by the makers as the only 'sensible' British-designed and manufactured microcomputer, its uses are small business and educational applications and in distributed processing networks. Hardware distributors are being signed and agreements made with software houses to add software. It is not for the hobbyists. A warranty and U.K.-wide on-site maintenance is given.	£2,300-£8,000
<b>RESEARCH MACHINES LTD</b> PO Box 75, 209 Cowley Road, Oxford 0865 49793	<b>Research Machines 380Z</b> , Min size: 4K memory; 380Z processor; keyboard. Max size: 48K memory. <b>280Z</b> , 4K board plus connecting cables, £398. 32K board—identical in performance to the 380Z: £722.	Software: Basic interpreter; 12K Basic; Assemblers. A British system using CP/M software; delivery times are about 6 weeks at the moment. A minifloppy disc system is on trial. Sintel is the sole distributor.	From £830
<b>SCIENCE OF CAMBRIDGE</b> 6 Kings Parade, Cambridge 0223 312919	<b>MK 14</b> , Min size: 8060 SC/MP; ½K user memory; ½K PROM with monitor program; Hex keyboard and 8-digit, seven-segment display; interface circuitry; 5v regulator on board. To this can be added: ½K RAM (£3-60); 16 I/O chip (£7-80); cassette interface kit (£5-95); cassette interface and replacement monitor (£7-95); PROM programmer (£9-95).	Software: None provided, but a 100-page manual includes a number which will fit into 256 bytes covering monitors, maths, electronics systems, music and miscellaneous. Based on American National Semiconductor chips. Science will soon have a VDU interface and large manual on user programming. Half of sales are to hobbyists, half to engineers.	Basic price is £39-95. All prices are exclusive of VAT
<b>STRUMECH ENGINEERING ELECTRONICS DIVISION (SEED)</b> Portland Place, Coppice Side, Brownhills, Walsall, Staffordshire 05433 4321	<b>MSI 6800</b> , Min size: 16K memory; Act 1 terminal (keyboard); cassette interface. Max size: Three disc systems are offered: Minifloppy disc system with triple drives of 80 bytes each and 32K memory. Large floppy system with dual 312K-byte capacity disc and 32K of memory. Hard disc system with 10MB, five fixed, five removable, and 56K.	Software: Basic interpreter and compiler; super editor assembler; text processor on small disc system. This is an American-designed system which is being increasingly manufactured in U.K. A SEED survey of its sales showed 60% of the customers were educational establishments, a further 10% research institutes, 10% hobbyists and the rest commercial companies. A distributor network is being set up.	Basic system is £1,100 (£815 as kit); Minidisc—£2,500; large floppy disc £3,200; hard disc £8,000-plus
<b>TANDY CORPORATION</b> Bilston Road, Wednesbury, West Midlands 021-556 6101	<b>TRS-80</b> , Min size: Level 1 4K memory; video monitor; cassette; power supply. Max size: Level 2 16K memory; line printer, floppy disc system.	Software: Basic; some business packages. An American system from the 200-outlet Tandy chain—The Level 1 is aimed at the hobbyist and education market and Level 2 at small business applications.	Level 1—£499; Level 2—£2,434

## 224 ARTICLES

Kilobaud has more articles than any other microcomputer magazine. During 1977, for instance, there were 224 articles in Kilobaud—880 pages of articles—that's like a very large encyclopedia of microcomputing. There will be even more articles in 1978.

## FOR THE BEGINNER

Though Kilobaud covers both the technical and programming sides of microcomputers, each article is written with the beginner in mind. No other magazine makes it as easy to understand microcomputers.

## THE BEST PROGRAMS

Only Kilobaud offers programmers both the publication of their programs in the magazine plus a large royalty for the program if it is issued on cassettes. Is it any wonder all of the really good programs are being published in Kilobaud? You'll find the best in games, diagnostics, teaching, music, business, etc., programs in Kilobaud. We're very heavy on programs.

## HOBBY OR BUSINESS?

Both businessmen and hobbyists want the same thing: to understand microcomputers—and this is the purpose of Kilobaud. KB also has articles aimed at the businessman to help him know what is available and what it will do.

## THE PUBLISHER

Kilobaud is published by the same people who put out 73 Magazine—the largest of the amateur radio magazines.

## MONTHLY COLUMNS

Keep up with the latest developments and readers' programs through the letters column, a KIM column, one on the TRS 80, a column on BASIC, etc. The editorials will keep you up to date on money-making ideas, the progress of the industry and more. The New Products column is particularly useful, including the results of tests of the latest equipment in the Kilobaud microcomputer laboratory—the most complete in the industry.

## SUBSCRIBE TO KILOBAUD

You can get Kilobaud fast. Copies are flown to Europe immediately upon publication and mailed directly from the United Kingdom, so your copies are current. Send subscription orders for United Kingdom and Europe, £20 sterling per year, to:

L. P. Enterprises  
313 Kingston Road, Ilford, Essex. 01-553 1001  
Barclay Card, VISA, Diner's Club and American Express,  
Access Card honored.



If you only  
read ONE  
American  
computer  
magazine...

it should be

## The world's best-selling personal computer



# APPLE II

- \* New powerful basic and new graphics on Rom. £110 card.
  - \* Talk to Apple with voice recognition, speaker trained, 32 word vocabulary. £165 card.
  - \* Colour Graphics. High resolution 280h x 192v, 6 colours, easy-to-use. 16 colours, very powerful. Low resolution 40h x 48v.
  - \* Apple's disks. Powerful DOS. 116K bytes capacity, multiple drives, fast access. £425.
  - \* Use Apple as a computer terminal 110 or 300 BAUD. Full or half duplex or use with a Dec-writer. £110 card.
  - \* Use any 8 bit parallel printer with Apple II.
- Print up to 3,700 lines per minute. 255 character lines, upper and lower case. £110 card.

Personal  
Computers  
Limited

194-200 Bishopsgate, London E.C.2. 01-283 3391

● Circle No. 152

● Circle No. 153

# microsense computers

A Division of Data Efficiency Limited  
MICROCOMPUTERS FOR BUSINESS & PLEASURE

## Professional Dealers Required

We are pleased to announce that we have obtained an exclusive agency for **MICROSTAR** Computers manufactured by MICRO V CORPORATION of the U.S.A. The **MICROSTAR 45 PLUS** system is unique at its price, less than £5000, since it offers a MULTI-USER, MULTI-TASKING, FLOPPY DOS, 64k RAM, 1.2 Mb Disc (on 2 drives), BASIC, & UPDATE™ DBMS. The system has three time-sharing RS232 I/O interfaces and can also run a further background process simultaneously. CP/M DOS also available.

We invite enquiries from qualified Dealers who wish to sell **MICROSTAR** systems in specific territories in England, Scotland, Wales and Northern Ireland.

We also have certain area Distributorships for the **APPLE II based ITT 2020**, and are looking for Dealers within a thirty mile radius of Hemel Hempstead (excluding certain areas of London) and in the counties of Devon and Cornwall.

Applications should preferably be made in writing to Mike Brewer or Bill Mercer, including relevant supporting information, or they may telephone Hemel Hempstead (0442) 63561.

Finway Road, Hemel Hempstead, Herts HP2 7PS

Telex: 825554 DATEFF G

● Circle No. 154

## Business Men in the Midlands

Thinking of buying a Computer ?

Bewildered by the Choice ?

Let us help you through the Maze ?

During 1979 we shall be holding a series of one-day seminars on the use of microcomputers in business.

- Attendance at each seminar limited to 20 people.
- Individual attention to your problems.
- Talks by experienced business Consultants.
- Demonstrations of a full range of *working* business software packages.
- Demonstrations of microcomputers in action.
- No prior knowledge of computers necessary.
- Lunch and refreshments available.

To date we have been involved in the installation of more than 40 small business systems. Why not gain the benefit of our experience ? Attendance fee £50.

For further details contact: Mrs D. G. Smith  
Video Software  
Stone Lane  
Kinver  
Stourbridge  
West Midlands.

Tel: Kinver (038483) 2462 or Stourport (02993) 77498.

# MICRO COMPUTER COURSES

Seminars on microcomputers.  
Applications for the computer lay man

Learn how to use a micro on our three-day practical course for small groups in London, £120; includes an introduction to Basic.

Learn what a micro can do for you and how to choose one; suitable for management as well as users, £50.

Beyts Logic Ltd.  
Windmill Hill, Sunbury,  
Middx. U.K.  
Telephone (09327) 86262  
Telex 928185

# BEYTS LOGIC

● Circle No. 155

● Circle No. 156



## THE NEWBEAR COMPUTING STORE



NASCOM I  
now in stock  
£197.50 (+ 8% VAT)

The Bear announces its new store at:-  
2 Gatley Road,  
Cheshire  
Tel: 061-491 2290  
callers welcome, mail order to Newbury.

BOOKS	P&P
Computer Designs 77-68 a 6800 Microcomputer	£7.50 50
WB-1 a TTL Microcomputer	£6.50 50
Spare Diagram Set for WB-1	£1.00 50
Zilog Z-80 Technical Manual	£4.00 50
Z-80 PIO Manual	£2.50 50
Z-80 Programming Manual	£4.00 75
Motorola: Understanding Microprocessors	£2.75 30
M6800 Microprocessors Programming Manual	£4.50 50
M6800 Applications Manual	£9.50 100
6800 Assembly Language Programming	£6.95 50
Understanding Microcomputers	£7.50 50
Z-80 Programming for Logic Design	£5.95 50
How to Buy and Use Microcomputers	£6.95 75
Microcomputer Primer	£5.55 75
Adam Osborne Introduction to Microcomputers	£5.25 50
Vol. 0 Beginners Book	£5.95 50
Vol. 1 Basic Concepts	£4.95 50
Vol. 2 Some Real Products	£11.95 100
6800 Programming for Logic Design	£5.95 50
6800 Programming for Logic Design	£5.95 50
Some Common Basic Programs	£8.95 50
Payroll with Cost Accounting in Basic	£9.95 100
Sydex Microprocessors	£8.00 50
Microprocessor Interfacing Techniques C20	£8.00 50
Scelbi 8080 Software Gourmet Guide Cook Book	£7.95 50
6800 Software Gourmet Guide Cook Book	£7.95 50
The Scelbi Byte Primer	£9.95 100
What to do after you hit return	£7.00 75
PCC Reference Book on Home Computers	£4.95 50
Instant Basic	£4.95 75
My Computer Likes Me	£1.65 30
Games with a Pocket Calculator	£1.75 30
Games Tricks & Puzzles for a Hand Calculator	£2.45 30
Best of Creative Computing Vol. 1	£4.95 75
Best of Creative Computing Vol. 2	£6.95 75
Hobby Computers are Here	£3.99 50
Best of Byte	£8.95 75
101 Basic Computer Games	£5.50 75
The Home Computer Revolution	£3.45 50
Computer Lib.	£5.95 50
First Book of Kim	£7.00 50
Dr. Dobbs Journal (Vol. 1)	£10.00 75
Z-80 Microcomputer Handbook	£7.25 50

## SEND FOR OUR NEW CATALOGUE

### CROMEMCO S-100

### Z2 SYSTEM

including cabinet

ZPU and PSU

Kit £395

Assembled and tested £575

8080A Bugbook	£6.95 75
TTL Cookbook	£6.30 50
How to Program Microcomputers (Bardan)	£6.30 50
Microprocessors Systems	£5.70 50
Take a Chance with your Calculator	£4.95 50
Home computers Questions and Answers	£5.95 50
Vol. 1 Hardware	£5.95 50
Vol. 2 Software	£5.95 50
Data Acquisition Handbook	£2.50 50
SCMP Applications Manual	£4.00 50
Getting Involved with your own Computer	£4.75 50
Your Home Computer	£4.95 50
Using the 6800 Microprocessor	£6.25 50
Basic Programming in Real Time	£5.95 50
IC Timer Cookbook	£6.95 75
Active Filter Cookbook	£10.45 75
IC OP-AMP Cookbook	£9.05 75
Kim-1 User Manual	£7.00 75
6500 Programming Manual	£7.00 75
6500 Hardware Manual	£7.00 75
The New Hobby Computers	£3.95 30
Accounts payable and accounts received	£9.95 75
Computer programs that work	£2.40 30

SYM-1  
(formerly VIM-1)

THE NEW 6502 BASED MICRO FROM SYNTEREK. FULLY ASSEMBLED AND TESTED £199.00 PLUS 8% VAT. CARRIAGE £1.00. SEND FOR DATA SHEET.

### BEAR BAGS (Kits)

1 77-68 CPU P.C.B. Components and Edge Connectors	£45.00
2 77-78 LED's and Switches	£14.95
3 77-68 Power Supply *	£17.95
4 77-68 19" Bu Rack and Backplane *	£27.70
5 77-68 4K RAM P.C.B. and Components	£75.00
6 77-68 Mon 1 P.C.B. and Components	£50.70
7 4K Ram Excorsior P.C.B. and Components	£71.50
8 8K Ram Excorsior P.C.B. and Components *	£160.00
9 Pettitevid V.D.U. Kit	£85.00
10 Kansas City Cassette Interface	£18.95
11 U.H.F. Modulator	£4.50
12 77-68 VDU P.C.B. and Components	£69.50
13 77-68 Mon 2 P.C.B. and Components	t.b.a.
14 Prom Programmer P.C.B. and Components	£35.00
15 Promverter	£8.50

Plus VAT 8%  
50p Postage & Packing  
\* £1.00 Postage and Packing

### PCB and COMPONENTS 77-66 PRINTED CIRCUIT BOARDS

77-68 CPU P.C.B.	£10.00
77-68 4K Ram P.C.B.	£10.00
77-68 Mon 1 P.C.B.	£10.00
77-68 V.D.U. P.C.B.	£10.00
Jade S100 Bus 280 CPU board	£26.25
S100 Bus photocopying card	£12.57
Excorsior Compatible Motherboards (8 slot)	£23.50
8K Ram P.C.B.	£10.00
Veroboard Backplane 8" x 19"	£4.30
77-68 Extender card	£4.10
ASCII Keyboard assembled and tested	£86.00
Keyboard Kit	£56.00
Keyboard Case	£20.33
U.V. Prom Eraser	£56.00
S100 Bus 9 slot motherboard	£19.50

Goods are normally shipped within 24 hours, subject to availability. Barclaycard & Access. VAT at 8% for Hardware Components. 30p postage and packing unless otherwise stated. Cheques to be made out to The Newbear Computing Store. Send for an up-to-date catalogue to The Newbear Computing Store, 7 Bone Lane, Newbury 0635-49223. Callers are welcome Monday to Saturday 9.00a.m.-5.30p.m., but please ring to let us know when you are calling.

● Circle No. 157

PRACTICAL COMPUTING February 1979

# It's not so easy as it might appear

MUCH has been said of chess and other games but although everyone knows noughts and crosses, it has been unfairly forgotten. Noughts and crosses is not so easy to play as you might think. Making the computer play a watertight game involves recognising patterns, which we have achieved by some algorithms and some sledge-hammer techniques using IF statements.

The program is based on a machine-language program written by the author in 1973 for a Texas 960 minicomputer. Translating to Basic was not easy, as Basic is really not suitable for this kind of work. String matrices are hard to use, since only one result is allowed from an IF statement.

You are O, the computer is X, and you play first. A matrix of nine numbers is displayed representing the nine squares. You must enter the number of the squares you want to enter and the appropriate square is changed to a zero. At the same time the computer's square is changed to an X.

The matrix is displayed again and you then choose your next square. If you win or lose, suitable messages are displayed. If you draw you get a replay. If you use a square number which has already been used you get "CHEAT".

## Translation

The only string variable is S\$ which is used as a status indication which can be printed. If your Basic does not have string variables, use different values for OK, WIN, LOSE and then use IF statements to print different messages.

ELSE: If your Basic does not have this feature you will have to add extra lines, e.g. 391 GOTO 430 deals with line 390. To deal with 400 and 420 move them to 401 and 421. At 400 and 420 write P0=8. 210 and 430 will need additional IF statements.

EXIT: This is needed to get out of a FOR loop early without causing a stack error. Some Basics will allow GOTO instead, without causing an error. Otherwise if you don't have EXIT you can push P over the FOR limit then add another NEXT. For example to deal with line 460 change "EXIT 490" to "GOTO 1170". Then at 1170 P=9:NEXT P: GOTO 490.

SPACE: If you run out of it then reduce the dimension of S\$, cut down the messages and delete the REMs. You could also try deleting one or more of the rules, which will increase your chance of winning. For example, lines 250-280,

or 290-360, or 370-420, or even all of 230-440 which will make it very easy to win.

## Operation

10-50: dimensions the matrix, initialises the status word (literally) S\$ and puts the values 1-9 in the matrix. Note that element 0 is not used.

80: is where the program loops back on each play. F is made = 1 when the computer blocks a row to prevent another entry in lines 210 onwards.

100: calls 560 to print the matrix. This is treated as two dimensions V & H and the contents are printed as they are. O is represented as 0 and X is represented by -1. Thus lines 600 and 630 print X whenever -1 is encountered.

110: calls 690 to see if anyone has won. On the first time round no-one has, of course, but on subsequent loops it could be the computer.

120: If S\$ changes its status the game finishes.

130-160: inputs the user's square, checks it, and enters 0 in the matrix.

170-180: the matrix is then re-checked to see if the user has won.

190: calls 860 to check if there is a row with only two entries, either of 0s (to be blocked) or of Xs (to win) and enters an X in the remaining square.

210: If the above tests fail the computer tries for the centre square.

250-280: biases the computer's moves to the corners.

290-360: checks L-shapes. If the user has played one corner and an opposite side then the potential triangle must be blocked.

380-420: checks for triangles threatening.

430: Implements the decisions made in 250-420, if possible. If not then. . .

450: Anywhere free will do for the X. If there is nowhere free, the game must have ended in a draw.

510: the game ends by displaying the matrix and printing the status.

```

LIST
10 DIM M(10),S$(30)
20 S$="OK"
30 FOR P=0 TO 9/REM INIT MAT
40 M(P)=P
50 NEXT P
60 PRINT "NOUGHTS AND CROSSES. YOU ARE O,
I AM X"
70 PRINT "YOU HAVE FIRST GO: ENTER THE
SQUARE NUMBER YOU WANT"
80 F=0
90 PRINT
100 GOSUB 560/REM PRINT MAT
110 GOSUB 690/REM TEST LNS OF 3
120 IF S$ < ">"OK" THEN 520
130 INPUT "ENTER SQ: ",P1
140 IF M(P1) < I THEN PRINT "CHEAT"
150 IF M(P1) < I THEN 540
160 M(P1)=0
170 GOSUB 690/REM RECHK LNS 3
180 IF S$ < ">"OK" THEN 510
190 GOSUB 860/REM CHK PRS
200 IF F=I THEN 80
    
```

```

210 IF M(5) > 0 THEN M(5)=-1 ELSE 240
220 GOTO 80
230 REM CHECK L SHAPES
240 P0=0
250 IF M(1)+M(5) < I THEN P0=3
260 IF M(3)+M(5) < I THEN P0=9
270 IF M(9)+M(5) < I THEN P0=7
280 IF M(7)+M(5) < I THEN P0=1
290 IF M(1)+M(8)=0 THEN P0=7
300 IF M(1)+M(6)=0 THEN P0=3
310 IF M(3)+M(4)=0 THEN P0=1
320 IF M(3)+M(8)=0 THEN P0=9
330 IF M(9)+M(2)=0 THEN P0=3
340 IF M(9)+M(4)=0 THEN P0=7
350 IF M(7)+M(2)=0 THEN P0=1
360 IF M(7)+M(6)=0 THEN P0=9
370 REM CHECK TRIANGLES FORMING
380 IF M(1)+M(5)+M(9)=-1 THEN 400
390 IF M(3)+M(5)+M(7)=-1 THEN 420 ELSE 430
400 IF M(1)+M(9)=-1 THEN P0=3 ELSE P0=8
410 GOTO 430
420 IF M(3)+M(7)=-1 THEN P0=1 ELSE P0=8
430 IF M(P0) > 0 THEN M(P0)=-1 ELSE 450
440 GOTO 80
450 FOR P=1 TO 9/REM PUT X ANYWHERE FREE
460 IF M(P) > 0 THEN EXIT 490
470 NEXT P
480 PRINT "DRAW"/GOTO 20
490 M(P)=-1
500 GOTO 80
510 GOSUB 560
520 PRINT S$
530 PRINT "I ENJOYED THAT GAME"
540 PRINT "IF YOU WANT ANOTHER GO, TYPE
'RUN'"
550 END
560 REM PRINT MATRIX
570 PRINT TAB(20),
580 FOR V=0 TO 2
590 FOR H=0 TO 2
600 IF M(H+V*3+1) < 0 THEN 630
610 PRINT M(H+V*3+1), " ",
620 GOTO 640
630 PRINT " X "
640 NEXT H
650 PRINT/PRINT/PRINT TAB(20),
660 NEXT V
670 PRINT
680 RETURN
690 REM CHECK FOR LINES OF 3
700 FOR P=1 TO 7 STEP 3
710 IF M(P) <> M(P+1) THEN 730
720 IF M(P+1)=M(P+2) THEN EXIT 830
730 NEXT P
740 FOR P=1 TO 3
750 IF M(P) <> M(P+3) THEN 770
760 IF M(P+3)=M(P+6) THEN EXIT 830
770 NEXT P
780 P=5/IF M(P) <> M(P-4) THEN 800
790 IF M(P)=M(P+4) THEN 830
800 IF M(P) <> M(P-2) THEN 820
810 IF M(P)=M(P+2) THEN 830
820 P=0/RETURN
830 IF M(P)=0 THEN S$="DRAW IT, I'VE LOST!"
840 IF M(P)=-1 THEN S$="YOU TWIT, I WIN!"
850 P=0/RETURN
860 REM CHK PAIRS
870 FOR P=1 TO 3/REM VERT ROWS
880 P0=P+3/IF M(P)=M(P+6) THEN GOSUB 1140
890 IF F=I THEN EXIT 950
900 P0=P/IF M(P+3)=M(P+6) THEN GOSUB 1140
910 IF F=I THEN EXIT 950
920 P0=P+6/IF M(P)=M(P+3) THEN GOSUB 1140
930 IF F=I THEN EXIT 950
940 NEXT P
950 IF F=I THEN RETURN
960 FOR P=1 TO 7 STEP 3/REM HORIZ
970 P0=P+1/IF M(P)=M(P+2) THEN GOSUB 1140
980 IF F=I THEN EXIT 1040
990 P0=P/IF M(P+1)=M(P+2) THEN GOSUB 1140
1000 IF F=I THEN EXIT 1040
1010 P0=P+2/IF M(P)=M(P+1) THEN GOSUB 1140
1020 IF F=I THEN EXIT 1040
1030 NEXT P
1040 IF F=I THEN RETURN
1050 FOR P=2 TO 4 STEP 2/REM DIAGONALS
1060 P0=5/IF M(5+P)=M(5-P) THEN GOSUB 1140
1070 IF F=I THEN EXIT 1130
1080 P0=5+P/IF M(5)=M(5-P) THEN GOSUB 1140
1090 IF F=I THEN EXIT 1130
1100 P0=5-P/IF M(5)=M(5+P) THEN GOSUB 1140
1110 IF F=I THEN EXIT 1130
1120 NEXT P
1130 RETURN
1140 IF M(P0) < 1 THEN RETURN
1150 M(P0)=-1
1160 F=I/RETURN
READY
    
```

Written in North Star Basic by D. N. Sands and staff at Sands-Whiteley Research & Development Ltd., microcomputer consultants, Royston, Herts.

# AIM 65

£249.50 + VAT

- FEATURES INCLUDE:**
- \* 20 COLUMN PRINTOUT
  - \* 20 CHARACTER ALPHANUMERIC DISPLAY
  - \* FULL 54 KEY TERMINAL-STYLE KEYBOARD
  - \* TTY INTERFACE
  - \* TWIN CASSETTE INTERFACE
  - \* RAM — 1K TO 4K OPTIONS

- OPTIONS INCLUDE:**
- 8K BASIC INTERPRETER ROM
  - 4K ASSEMBLER/EDITOR ROM

AIM 65 comes to you fully built and tested with a full alphanumeric keyboard, 20 character display and a 20 column printer — for keeping a permanent record of all your work. Available in 1K- and 4K-byte RAM versions, AIM 65 is designed around the 6502 CPU, which has 64K address capability with 13 addressing modes. This is the microprocessor at the heart of many other, more costly, systems such as PET and APPLE.

AIM 65 has a 4K ROM-resident monitor program for all peripheral control and user programming functions.

Spare sockets are included for expanding on-board program memory via user PROM-based programs and/or Rockwell assembler, text editor and BASIC interpreter plug-in options.

AIM 65 has a connector for external access to system bus for memory and I/O expansion, a separate connector

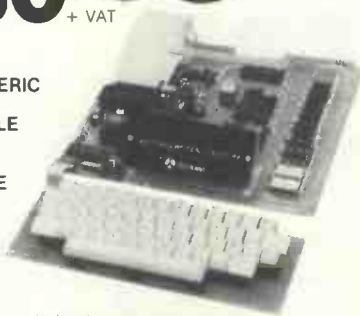

for interfacing a teletype and two cassette recorders. There is a user-dedicated Versatile Interface Adaptor, featuring three 8-bit, bidirectional ports (two parallel, one serial) and two 16-bit interval timer/event counters — thus allowing the user to interface his own system, without extra interface devices in many cases.

AIM 65 is probably the most effective, low-cost microcomputer development system available — an invaluable educational aid to first time users and an ideal general purpose micro-computer for the engineer.

AIM 65 is available in the UK only from PELCO ELECTRONICS LTD at £249.50 + VAT, complete with User's Manual and Schematic, R6500 Programming and Hardware Manuals and a handy pocket reference card.

## Pelco (Electronics) Ltd

Enterprise House,  
83-85 Western Road, Hove, Sussex BN3 1JB  
Telephone: Brighton (0273) 722155

Buy it with your Access or Barclaycard.



● Circle No. 158

## millhouse designs limited

now DISPLAYING and DEMONSTRATING

the PET 2001-8 computer

in our new Camberley showrooms

All Commodore and Petsoft programmes available for instant running and evaluation

Engineering and Programming experts at hand to discuss your precise requirements

Centronics line-printers in stock with PET interfaces

for full details

MILLHOUSE DESIGNS Ltd.  
185 LONDON ROAD, CAMBERLEY.  
Telephone Camberley 23581

● Circle No. 159



Introducing the Lyme 4000 family of visual display computer terminals, the British-designed and built Terminal exploiting all the very latest Microprocessor and N-MOS circuits. Only 32 Chips provide a VDU giving the highest performance and flexibility at low cost.

- \* 4,000 character page with 1,920 characters viewable at any one time
- \* 64/96 character set
- \* Switchable transmission speeds 75–9,600 bps (split speeds optional)
- \* HDX FDX (Model 4002) Block Mode (Model 4004)
- \* Dual interface—RS232C and 20 ma current loop
- \* Protected areas (defined by reduced intensity)
- \* XY Cursor addressing, 12" diagonal screen
- \* 12 × 7 dot matrix upper and lower case
- \* Character delete and insert
- \* Up to 16 dedicated function keys. Printer Port RS232 optional
- \* One off end user price £645

Lyme Peripherals Limited, 2 Avenue Court, Farm Avenue, London NW2 2PT.  
Tel: 01-4520490.

● Circle No. 160





# Moving software from one micro to another

Mark Witkowski looks at how to overcome the difficulty of moving software written for one make of computer to another. The main method of attacking this problem is to disassemble and relocate the program so that it fits on to your own computer.

In this and next month's issue he will describe how to tackle this task, which is not as difficult as it may seem, and which is applicable not only for the 6800.

DISASSEMBLERS are a most useful software tool for microprocessors. A good deal of software available on the current range of micros is supplied only in object form. If the original code was written in assembly language, the program source listing will probably be too bulky to be supplied.

Not providing a listing also protects the author's effort in programming. If the user's set-up is not identical to that available to the author, however, substantial changes may be called for if the program is to run satisfactorily. A typical instance might be that the user's system has read-only-memory-based code at locations which contained random access memory when the program was devised.

Different monitors will assume different stack locations and monitor routines will be at different addresses. Most programs use at least the monitor transport routines. Any of those things will prevent the program running properly.

Correcting these deficiencies involves understanding how the program works and then altering the code. When high-level languages become common on microprocessors, even if the program listing is supplied, there will still be times when understanding what is happening at the machine level is essential.

## Simple process

Plodding through a hexadecimal dump constitutes an almost impossible task. In any case, it is far more difficult than it need be. A disassembler, and there are many available, will translate the hex number into the original mnemonic form of the assembly language. For example, "E7" becomes "STAB" or "54" to "LSRB", which is of far more value.

The process is a simple one. In the Motorola M6800 instruction set, each of the 256 possible instructions either maps on to a mnemonic or is totally unused. By setting-up a table of such 'words' and then using the corresponding numeric value of the instruction as a key to select

the correct one, it is a trivial matter to print the instructions in the helpful mnemonic form.

The disassembler discussed here is coded in the Basic programming language. There are numerous disadvantages to using Basic for disassembly, compared to writing it directly in assembly code. The program is much larger, the resident interpreter is required, the whole taking nearly 16K bytes. A hand-coded version would only take about 1.5K.

## More than necessary

Basic uses all the resources inefficiently. The program is stored in random access memory as literal lines or text. The list of mnemonics is stored as 255 string variables in an array. SWTP Basic fixes the string variable storage length at 18 characters, even though the program uses only the first five in each string, at most. Therefore the mnemonic table alone uses 4,596 bytes, about 3,500 more than it needs.

If space were at an absolute premium, the mnemonics could be packed three to a string but the code would be made more complex as a result. Further, the mnemonics are stored twice, once in the source program in DATA statements and again in the string variables.

Considering the trouble involved in inputting the table for each run of the program, I am content to leave the DATA statements. Basic also executes code very slowly. There must be a factor of several hundred in run-time speed for the Basic over well-written assembly code for this application. This is not surprising when one considers that the interpreter must look at each character in the source before doing anything, and that the arithmetic is done on numbers accurate to 10 places.

Worse than these, which are bad enough, the Basic interpreter and program sit between locations zero and 16K—just where most programs to be disassembled will be themselves. One could use the

(continued on next page)

## PET CORNER

Lotus now carry an exciting range of products for your CBM PET.

### DUAL DRIVE MINIFLOPPY

- \* Dual minifloppy with 100K per disc side—200K online.
  - \* DISKMON in ROM on controller board, plugs into Expandapet.
  - \* DISKMON automatically reorganises free space after SAVE or ERASE.
  - \* Full disc software support.
  - \* FORTRAN & PLM compilers in February.
  - \* 90-day warranty on hardware.
  - \* Initial quantities limited.
  - \* Available early January.
  - \* Phone or write for full details.
  - \* Needs minimum 16k Expandapet expansion memory.
- DKH641 Dual Minifloppy system £916.00 plus 8% VAT.

## EXPANDAPET MEMORY

Write for full details

- \* Mounts inside PET
- \* Runs from PET's own power supply
- \* Takes 10 minutes to fit
- \* Includes memory test program
- \* 6 month warranty

## NEW LOW PRICES

- 16K.....£276 + 8% VAT
- 24K.....£337 + 8% VAT
- 32K.....£394 + 8% VAT

## MUSIC BOX

Turns your PET into a programmable musical instrument. You can record and play up to 90 pages, 16 notes per page. change tempo, key, etc.

£37.50 inc. VAT & P & P

## T.I.S. WORKBOOKS

A set of 5 workbooks to give you a full understanding of all the ins and outs of your PET more fully than any previous manuals.

£15.95 per set. inc. P & P

Lots of software and other goodies

Send large SAE.

## LOTUS SOUND

4 Morgan Street, London E3 5AB

Mail order only

Callers by appointment.  
01-981 3993 (24 hr answer)  
Telex 261426 Attn: Lotus Sound

● Circle No. 161

# PET Sales & Service?

We've got you covered . . . with a unique Nationwide network of PET-orientated dealers offering:

- ★ PET SALES
- ★ PET SERVICE

many maintenance agreements already in force

- ★ PET SOFTWARE

- ★ FULL RANGE OF PET peripherals including the Teletype M43 printer.

For instant attention from the PET SPECIALISTS ring:

**SCOTLAND**  
**041-776-4388**

Robox Office Equipment Ltd,  
84 Townhead,  
Kirkintilloch, Glasgow

**NORTH**  
**0632-774540**

Currie & Maughan Systems,  
204 Durham Road,  
Gateshead,  
Tyne & Wear

**MANCHESTER &  
NORTH WEST**

Please enquire in the first instance to:-

**01-254 9293**

C.S.S. (Business Equipment) Ltd,  
502 Kingsland Road,  
London E8 4AE

**MIDLANDS**  
**0602 206647**

A.J.R. Office Equipment Services,  
5 Church Drive,  
Daybrook,  
Nottingham

**BRISTOL**  
**0272-651449**

C.S.S. (Bristol) Ltd,  
351 Fishponds Road,  
Bristol BS5 6RT

**LONDON & HOME  
COUNTIES**

**01-254-9293**

C.S.S. (Business Equipment) Ltd,  
502 Kingsland Road,  
London, E8 4AE

**CBM APPOINTED  
GOVERNMENT  
DEALERS**

● Circle No. 162

(continued from previous page)

disassembler to re-locate the Basic somewhere else in memory. In fact, the dual considerations of patching the Basic to work on our system, and the possible need to re-locate it, provided most of the impetus to do this work. It was also something of a challenge to write a program in Basic to disassemble itself.

On the advantage side, the single fact that this program, written in a high-level language, is so much easier to write, debug and describe goes all the way in counter-balancing the disadvantages. Those are among the reasons given most often for using high-level languages.

In time- or space-sensitive applications the algorithm—which is generally language-independent—may be tried and tested using the high-level languages and then be re-coded carefully, possibly with a slight overall reduction in the time it takes to go from the initial idea to the use of the final printout, rather than going 'from cold' directly in assembler.

This route certainly gives a greater understanding of the problem and its solution. Whenever a program is used and then re-coded in this way, minor, and sometimes major improvements become apparent and are incorporated in the final program.

The problem with which we are faced is to take an apparently arbitrary collection of binary digits and restore them to a readable form. How can a hexadecimal string such as "9F0D207A8D" and the like be presented in a usable way? Each manufacturer produces, with every processor family, an assembly language format. Motorola is no exception. Each instruction to the microcomputer to perform an action is given a mnemonic.

## Clearly related

This is related clearly to the English description of the action. Thus, Store the current contents of the A-accumulator into the location pointed to by the contents of the stack pointer, and then decrement the contents of the stack pointer register by one" maps first to "PSHA" and then to the hex "36".

It would not be impossible to devise a program thus to expand machine code. The result would be extremely verbose and ultimately, therefore, about as much use as the binary. Mnemonics—literally an "aid to memory"—provide a useful compromise. Because these mnemonics map so closely to the actual machine code the programmer has a considerable degree of control over the processor. In assembly language an instruction is written in the form: label, separator, operator (mnemonic), separator, operand, separator, comment. In most cases the separator is one or more spaces. So:

NEXT JMP BACK

means 'this instruction is called NEXT, if it executed jump (transfer control) to the instruction called BACK'. For those

machine instructions with an operand, and some which do not, it is stored in the one or two bytes following the instruction byte.

There are 72 mnemonics and 172 instructions for the M6800. This disparity is accounted for by each mnemonic being used in a number of modes. Motorola describes seven modes—inherent, relative, immediate, extended, direct, indexed and accumulator. For a full description of the modes, the *M6800 Microprocessor Programming Manual* should be consulted.

Briefly, inherent mode is a single-byte instruction and therefore has no operand. They will be used to affect the internal registers. The next instruction is found in the next byte.

Relative mode will be used to transfer control if some specific bit pattern exists in the condition codes. The operand is a single-byte signed number, which is added to the current program location to determine the next instruction to be executed. If the required bit pattern is not present in the condition code register, two is added to the program counter and the program continues with the next instruction. In both inherent and relative mode instructions there is only one mode for each mnemonic.

## Immediate mode

With immediate mode instructions the operand, always an expression which can be reduced to a single number, is placed in the next byte(s) and will be used as a constant. "ADDA #3" adds three to the A-accumulator. Immediate mode is indicated in the assembly language by preceding the operand by the "#" character.

With direct mode, the operand will specify the address of the machine location in which the number to be used will be found. "ADDA 3" means add the number stored in address "three" to the A-accumulator. The operand is stored in one byte and therefore the range of addresses to manipulate the data is limited to the first 256 bytes of the microprocessor address space. Extended mode allows a two-byte operand and so the address specified to contain the data can be anywhere in the 65536-byte address space.

Indexed mode provides a 16-bit wide index-register, the X-register, whose contents will specify the location at which the data is to be found. The one-byte operand consists of an unsigned binary number which will be added to the X-register before it is used to retrieve or store the data. This mode is denoted in the assembly language by placing the characters "X" directly after the operand.

Accumulator mode will specify which of the two accumulators, A or B, will be affected by a particular operation. In the language "A" or "B" may be placed directly after the operator field.

Subtract ("SUB") is an example of an

(continued on next page)

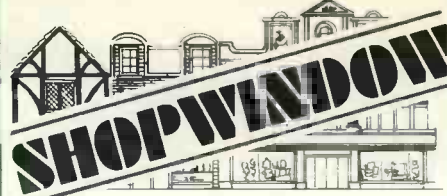

(continued from previous page)

instruction using many modes. This single mnemonic maps to eight machine code values, according to its mode:

SUBA #3	to 8003	(immediate)
SUBA 10	to 900A	(direct)
SUBA 0,X	to A000	(indexed)
SUBA \$2000	to B02000	(extended)
for the A-register mode, and:		
SUBB #3	to C003	(immediate)
SUBB \$10	to D010	(direct)
SUBB 0,X	to E000	(indexed)
SUBB 2000	to F007D0	(extended)
for the B-accumulator.		

The task for the disassembler is to take the hex digits shown on the right, and to produce the text shown on the left. For this program the method chosen is to store the relevant mnemonic for each of the 256 possibilities and then to use the numeric value as the subscript for the correct string array element.

Careful analysis of the operator values shows that each mnemonic is classed together according to the binary value of the operand. Thus for "SUB" bit 7 is always set, bit 0,1,2 and 3 are always unset and bits 5,6 and 7 carry the mode information (1XXX0000). The trade-off between the amount of code required to extract the mnemonic in this way scarcely justifies the storage gains.

Stored with each mnemonic in the data string is a digit which describes the addressing mode of the instruction. These are not identical to the ones described by Motorola, but are related closely. Inherent "2", immediate "3", direct "4", extended "5", relative "6" and indexed "7" remain the same. Accumulator mode is dispensed with, because they are explicitly mentioned in the stored string.

## New mode

A new mode, extended immediate "8", is added to cater for three instructions which do not follow the usual immediate mode rule of a single-byte operand. "CPX #", "LDX #" and "LDS #" all load or compare the 16-bit index and stack registers with a two-byte operand. Even when writing assemblers they have to be tested—for individuality and it seems strange that Motorola admits to their being different.

Undefined operator values are given the mode "1" and will cause the disassembler to print a "★NO INSTRUCTION" message. This should not be confused with the inherent "NOP" (no operation) instruction, which has the effect of moving program control to the next byte. Taking two machine cycles in the process, 'No Instruction' will cause the processor to cease computing, almost always requiring a re-set before it will continue. If such a byte is encountered while disassembling code, then it has gone past the end of the program, or has run into the program data areas.

The disassembler, after it has read the mnemonic table into the string array Q\$, begins by requesting a 'Start Address'. It uses this to extract the contents of that machine location with the Basic system

function "PEEK", (st. 640). The value returned is used to pick one of the mnemonics (st. 670) and its mode (st. 660) from the table. If that location contained zero (st. 650) it is a 'No Instruction', otherwise the mode (in variable A) transfers control to one of the eight code blocks with a computed goto (st. 680).

'No Instruction' mode (st. 1100 to 1110) prints a message, followed by a request for a new start location (st. 300). For the remaining seven modes the instructions are printed in a style as close to the original assembly code as possible. The label is replaced by the actual address of the instruction. Then the operator mnemonic is printed.

With the exception of inherent mode (st. 1200 to 1215), which has no operand, the operand field is printed next. For immediate mode (st. 1300 to 1355) a "#" is printed before the one-byte operand value. If the operand is between 32 and 125 it could be interpreted as a printing ASCII character.

In assembly notation an immediate ASCII character is denoted by preceding it with the string "#". This is placed in the comment field, as a useful guide (st. 1345). For direct (st. 1400 to 1435) and extended (st. 1500 to 1540) modes the operand is printed as a one- or two-byte number directly.

For relative mode (st. 1600 to 1645) the value of the operand is calculated from the current program location and the offset stored in the second byte. Signed arithmetic, available on the M6800, has to be simulated in Basic by statements 1610 and 1615. The operand is then the actual address to which control will transfer.

After the operand in indexed mode (st. 1700 to 1735) the string "X" is printed. Extended immediate mode (st. 1800 to 1835) is like ordinary immediate mode but with a double-byte operand. Printing the ASCII character equivalent is also meaningless then, so that code is omitted.

The program counter (P1) is always incremented by the correct amount before the control jumps back to statement. 440 and the next instruction is tackled. All numbers are printed in hexadecimal. Since the PEEK function returns a decimal number, a subroutine to convert decimal to hex had to be written, subroutine 4000. This routine will cater for both one- and two-byte numbers, provided the number is in the correct range.

## Division

The number is divided by 4,096, or 256 if it is one byte. The quotient is in the range zero to 15 and is converted to an ASCII character digit by statements 4080 to 4110 if it is between zero and nine. Ten to 15 get converted to "A" to "F" by statements 4120 to 4150. If the original number is too large this quotient will be 16 or greater, the output string (D\$) will

(continued on next page)

## HB COMPUTERS

Home of sophisticated  
Computer peripherals  
East Midlands Area  
distributor for  
PET 2001/Apple II

### PET PERIPHERALS

TV Interface, no cables, plugs directly into the PET userport, displays PET's superb graphics on standard TV monitor, £45.99 inclusive.

Expansion memory for PET from Europe's largest memory-board supplier The PLESSEY PETITE stand-alone, plug-in memory expansion available in 8K, 16K, 24K, 32K versions. Complete in case with built-in PSU. Competitive prices.

Make your PET audible with our SOUND BOX. Plugs directly into second cassette-port, no cables. Complete with demo-software. £12.99 inclusive.

DUST COVERS to protect your PET available in 4 colours (rust, beige, dark-blue, black.)

Only £9.50 inclusive. Please specify colour when ordering.

For details of all products listed, plus many more stock-lines of interest to home-computing buffs. (For circle number see below.) (Barclaycard and Access accepted for orders placed by telephone or post. All prices include post and packing (insured post extra).

22 Newland Street, Kettering  
KETTERING (0536) 83922/520910 2 lines

● Circle No. 163

## CAPITAL COMPUTER SYSTEMS

invite you to call in or phone  
to discuss your personal  
computer requirements

### CAPITAL HOUSE

29/30 Windmill Street  
London W1 (off Tottenham  
Court Road). 01-637 5551

● Circle No. 164

**PET FLOPPY DISK**  
Single £800 + 8% VAT + £2.50 P & P.  
Twin £1,300

**PET MEMORY**  
PMEI-16 16K BYTES £328 + 8% VAT  
PMEI-24 24K BYTES £388 + 8% VAT  
PMEI-32 32K BYTES £438 + 8% VAT  
INC. P & P.

We regret that owing to the high demand, orders can be accepted only on a cash with order basis—first come first served! Catalogue of hardware/software available (including printing/non print payroll-stock-control)

Intex Datalog Ltd.  
Eaglescliffe Ind. Est.  
Eaglescliffe  
Cleveland. TS16 0PN  
TEL.  
0642-781193

● Circle No. 165

# SHOP WINDOW

## P. I. P. S. COMPUTER SERVICES

North-East England distributors for the best selling micro, the

### APPLE II

Full range of accessories and software can be supplied.

Telephone John or Jane Page on (0632) 482359 to discuss your requirements.

## NEWCASTLE UPON TYNE

● Circle No. 166

SCOTLAND Distributors in Scotland for **NASCOM 1** SCOTLAND

Nascom 1 can be seen in action 9-5 Mon.-Fri. Callers welcome

**STRATHAND**  
44 St. Andrew's Sq. Glasgow G1 5PL

Enquiries invited from prospective Dealers throughout Scotland.  
**GLASGOW (041) 552 6731**  
Tel. order welcome with Access and Barclaycard.

● Circle No. 167

## DEVON

Apple Nascom Newbear Atari etc  
For computers and components  
Call or phone

### CRYSTAL ELECTRONICS

40 Magdalene Road,  
Torquay, Devon

**TORQUAY (0803) 22699**

● Circle No. 168

**NC** NewBear Computing Store

**SYM-1** (Formerly VIM-1)  
The new 6502 based Micro from Synertek ● Fully assembled and tested ● 1K byte storage, expandable on board to 4K byte ● 4K byte ROM monitor ● £199 plus 8% VAT £1 carriage ● Send for data

For further details: Visit Newbear Computing Store, 2 Gatley Road, Cheadle, Cheshire, 061-491-2290. Or visit, or write to: Newbear Computing Store, 7 Bone Lane, Newbury, Berks. 0635-49223. Send for catalogues of Hardware Components, Literature and Software.

● Circle No. 169

(continued from previous page)

be loaded with four exclamation marks, to denote a number format error.

Having thus determined the first digit the remainder is extracted and multiplied by the divisor (st. 4190), to give an integer remainder. The divisor is then divided by 16, so 4,096 becomes 256; 256 becomes 16; and 16 becomes 1, to extract the remaining digits, which are successively concatenated to the string D\$ as they are produced. After the final stage this string contains the answer.

By starting at 4000, and a divisor of 16, two-digit hex numbers are formed. By starting at 4040, a divisor of 4,096, four-digit numbers are obtained.

To maintain consistency with the assembly language, a dollar symbol is placed before each hexadecimal number in the operand. If the user prefers to work in decimal, each call of GOSUB 4000 or 4040 could be replaced by D\$=STR\$(P6), in which case the dollar symbol should be dispensed with. Should octal be your preferred number base, R1 will be set to 512 for one-byte and 32768 for two-byte numbers. Division by 8, not 16, is called for at statement 4200. Also the dollar prefix should be replaced by the 'commercial at' sign "@" to denote an octal number.

## Conversion

Subroutine 5000 converts a hexadecimal number stored in H\$ into a decimal in P1, making the input of the start address easier. Each digit is taken in turn, converted by the ASC system function (st. 5040) and statements 5050 to 5080 if "0" to "9" and 5090 to 5120 if "A" to "F" into a decimal number between 0 and 15. This is then added to a running total, which is multiplied by 16 prior to each addition. So OAEF is  $0 \times 4096 + A \times 256 + E \times 16 + F \times 1$ .

Figure 1 shows a portion of the disassembled listing. The first start address is that of the whole program. It is not very long before a 'No Instruction' is reached. Since the program must continue on an

Figure 1: Portion of disassembly

```

RUN
★ START ADDRESS (HEX)? 100
0100 JSR $0AEF
0103 JMP $0509
+ NO INSTRUCTION
+ START ADDRESS (HEX)? 0AEF
0AEF LDX # $0B09
0AF2 STX $A000
0AF5 STX $A006
0AF8 BSR $0AD3
0AFA LDAA # $00
0AFC STAA $96
0AFE LDAA # $40 # '@'
0B00 STAA $92
0B02 LDAA # $30 # '0'
0B04 STAA $93
0B06 JMP $0BA5
0B09 LDAA # $00
0B0B STAA $96
0B0D LDX # $8000
0B10 LDAB = $13
0B12 LDAA # $11
0B14 STAB $00,X
0B16 STAA $00,X
0B18 LDX # $8008
0B1B STAB $00,X
0B1D STAA $00,X
0B1F LDX # $800C
0B22 STAB $00,X
0B24 STAA $00,X
0B26 LDAB # $04
    
```

instruction, the new start address can be chosen from the operand of any program control change statement, JMP, JSR, or any branch instruction.

Each output line takes about three seconds to compute, not including the printout time. This is mainly due to the slow speed of the decimal to hex conversion routine. Figure 1 shows how useful this technique can be for understanding an object loaded program.

Compare this to figure 2, which is a listing produced by the 'T' command of

Figure 2: Hex notation using 'T' command of same area of memory as Figure 1

```

★ T 0100 0106
0100 BD 0AEF
0103 7E 0B09

★ T 0AEF 0B94
0AEF CE 0B09
0AF2 FF A000
0AF5 FF A006
0AF8 8D D9
0AFA 86 00
0AFC 97 96
0AFE 86 40
0B00 97 92
0B02 86 30
0B04 97 93
0B06 7E 0BA5
0B09 86 00
0B0B 97 96
0B0D CE 8000
0B10 C6 13
0B12 86 11
0B14 E7 00
0B16 A7 00
0B18 CE 8008
0B1B E7 00
0B1D A7 00
0B1F CE 800C
0B22 E7 00
0B24 A7 00
0B26 C6 04
    
```

the MSI monitor. This lists bytes in memory in instruction/operand format. The choice between a one-, two- or three-byte instruction is achieved in the MSI monitor with a miserly 28 bytes of program code, not including the command interpreter and print routines.

Figure 1 is still far from what is required. It would be much better if the listing produced by the disassembler re-constituted all four fields, the label as well. Further, it should need only a single start address, deciding automatically from where to continue disassembling. While it was about it, it could say where data locations were, and how many bytes were reserved.

By taking careful note of the values of the operands for particular modes of instructions, this is all possible. In part two techniques for full disassembly will be discussed. If a statement had a label originally, one is present on the listing. If a location was declared as data, then data is reserved. The aim is to produce a listing which could be fed directly back into an assembler, re-located if necessary.

```

LIST 99,680
0099 DATA "2NOP",2NOP,1,1,"1"
0100 DATA "2TAP",2TPA,2INX,2DEX,2CLV,2SEV,2CLC"
0101 DATA "2SEC",2CLI,2SEI,2SBA,2CBA,1,1,1,1,"2TAB"
0102 DATA "2TBA",1,2DAA,1,2ABA,1,1,1,1,6BRA,1,6BHI,6BLS,"6BBC"
0103 DATA "6BCS",6BNE,6BEQ,6BVC,6BVS,6BPL,6BMI,6BGE,"6BLT"
0104 DATA "6BGT",6BLE,2TSX,2INS,2PULA,2PULB,2DES,2TXS,"2PSHA"
    
```

(continued on next page)

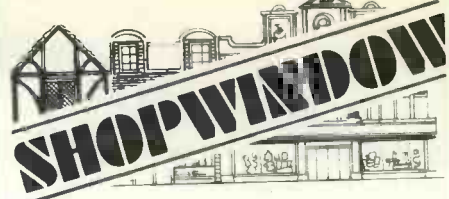

(continued from previous page)

```

0105 DATA "2PSHB", 1, 2RTS, 1, 2RTI, 1, 1, 2WAI
      "25WV"
0106 DATA "2NEGA", 1, 1, 2COMA, 2LSRA, 1, 2RORA,
      2ASRA, 2ASLA, 2SROLA, "2DECA"
0107 DATA "1", 2INCA, 2TSTA, 1, 2CLRA, 2NEGB,
      1, 1, 2COMB, "2LSRB"
0108 DATA "1", 2RORB, 2ASRB, 2ASLB, 2ROLB,
      2DECB, 1, 2INCB, 2T2TB, "1"
0109 DATA "2CLRB", 7NEG, 1, 1, 7COM, 7LSR, 1,
      7ROR, 7ASR, 7ASL, "7ROL"
0110 DATA "7DEC", 1, 7INC, 7TST, 7JMP, 7CLR
      5NEG, 1, 1, 5COM, "5LSR"
0111 DATA "1", 5ROR, 5ASR, 5ASL, 5ROL, 5DEC
      1, 5INC, 5TST, "5IMP"
0112 DATA "5CLR", 3SUBA, 3CMPA, 3SBCA,
      1, 3ANDA, 3BITA, 3LDA, "1"
0113 DATA "3EORA", 3ADCA, 3ORAA, 3ADDA,
      8CPX, 6BSR, 8LDS, 1, "4SUBA"
0114 DATA "4CMPA", 4SBCA, 1, 4ANDA, 4BITA,
      4LDA, 4STAA, 4EORA, "4ADCA"
0115 DATA "4ORAA", 4ADDA, 4CPX, 1, 4LDS
      4STS, 7SUBA, 7CMPA, "7SBCA"
0116 DATA "1", 7ANDA, 7BITA, 7LDA, 7STAA,
      7EORA, 7ADCA, 7ORAA, "7ADDA"
0117 DATA "7CPX", 7JSR, 7LDS, 7STS, 5SUBA,
      5CMPA, 5SBCA, "1"
0118 DATA "5ANDA", 5BITA, 5LDA, 5STAA,
      5EORA, 5ADCA, 5ORAA, "5ADDA"
0119 DATA "5CPX", 5JSR, 5LDS, 5STS, 3SUBB,
      3CMPB, 3SBCB, "1"
0120 DATA "3ANDB", 3BITB, 3LDB, 1, 3EORB,
      3ADCB, 3ORAB, "3ADDB"
0121 DATA "1", 1, 8LDB, 1, 4SUBB, 4CMPB, 4SBCB,
      1, 4ANDB, 4BITB, "4LDB"
0122 DATA "5TAB", 4EORB, 4ADCB, 4ORAB,
      4ADDB, 1, 1, 4LDB, "4STX"
0123 DATA "7SUBB", 7CMPB, 7SBCB, 1, 7ANDB,
      7BITB, 7LDB, "7STAB"
0124 DATA "7EORB", 7ADCB, 7ORAB, 7ADDB, 1,
      1, 7LDB, 7STX, "7SUBB"
0125 DATA "5CMPB", 5SBCB, 1, 5ANDB, 5BITB,
      5LDB, 5STAB, 5EORB, "5ADCB"
0126 DATA "5ORAB", 5ADDB, 1, 1, 5LDB, "5STX"
0190 RESTORE
0200 DIM (Q(255))
0220 FOR M9=1 TO 255
0230 READ Q(M9)
0240 NEXT M9
0300 INPUT "★ START ADDRESS (HEX)", H£
0310 GOSUB 5000
0320 IF P1(65537 THEN 440
0330 PRINT "★ INCORRECT NUMBER FORMAT"
0340 GOTO 300
0440 P6=P1
0450 GOSUB 4040
0460 L£=D£+" "
0640 I1=PEEK(P1)
0650 IF I1=0 THEN 1100
0660 A=VAL(LEFT(Q(I1), 1)
0670 O£=RIGHT(Q(I1), 4)
0680 ON A GOTO 1100, 1200, 1300, 1400, 1500, 1600,
      1700, 1800
READY
#
LIST 1000, 1835
1100 PRINT "★ NO INSTRUCTION"
1110 GOTO 300
1200 REM INHERENT MODE
1205 PRINT L£;O£
1210 P1=P1+1
1215 GOTO 440
1300 REM IMMEDIATE MODE
1305 I2=PEEK(P1+1)
1310 P1=P1+2
1315 P6=12
1320 GOSUB 4000
1330 PRINT L£;O£;" # $";D£;
1335 IF I2<32 THEN 1350
1340 IF I2>127 THEN 1350
1345 PRINT " # ";CHR£(I2);
1350 PRINT " "
1355 GOTO 440
1400 REM DIRECT MODE
1405 I2=PEEK(P1+1)
1410 P1=P1+2

```

```

1415 M3=1
1420 P6=12
1425 GOSUB 4000
1430 PRINT L£;O£;" # $";D£
1435 GOTO 440
1500 REM EXTENDED MODE
1505 I2=(PEEK(P1+1)★256)+PEEK(P1+2)
1510 P1=P1+3
1511 M3=1
1515 IF I1=126 M3=2
1520 IF I1=189 M3=3
1525 P6=12
1530 GOSUB 4040
1535 PRINT L£;O£;" # $";D£
1540 GOTO 440
1600 REM RELATIVE MODE
1605 I2=PEEK(P1+1)
1610 IF I2<128 P6=I2+2+P1
1615 IF I2>=128 P6=P1-254+I2
1620 M3=2
1625 IF I1=141 M3=3
1630 GOSUB 4040
1635 PRINT L£;O£;" # $";D£
1640 P1=P1+2
1645 GOTO 440
1700 REM INDEXED MODE
1705 I2=PEEK(P1+1)
1706 P6=12
1708 GOSUB 4000
1710 PRINT L£;O£;" # $";D£;" X";
1715 IF I1=110PRINT " !!DXD JMP";
1720 IF I1=173 PRINT " !!DXD JSR";
1725 PRINT " "
1730 P1=P1+2
1735 GOTO 440
1800 REM EXTENDED IMMEDIATE MODE
1805 I2=(PEEK(P1+1)★256)+PEEK(P1+2)
1810 M3=1
1815 P6=12
1820 GOSUB 4040
1825 PRINT L£;O£;" # $";D£
1830 P1=P1+3
1835 GOTO 440
READY
LIST 4000, 6000
4000 REM PRINT NUMBER IN P6 IN HEX (0-255)
4100 R1=16
4020 GOTO 4050
4030 REM PRINT NUMBER IN P6 IN HEX (0-65536)
4040 R1=4096
4050 D£=""
4060 P7=P6
4070 R2=INT(P7/R1)
4080 IF R2<0 THEN 4120
4090 IF R2<9 THEN 4120
4100 D£=D£+CHR(R2+48)
4110 GOTO 4180
4120 IF R2<10 THEN 4160
4130 IF R2<15 THEN 4160
4140 D£=D£+CHR(R2+55)
4150 GOTO 4180
4160 D£="!"
4170 RETURN
4180 IF R1=1 THEN RETURN
4190 P7=INT((P7/R1)-R2)★R1+0.499999
4200 R1=R1/16
4210 GOTO 4070
5000 REM CONVERT HEX STRING IN H£ TO DECIMAL
      IN P1
5010 P1=0
5020 FOR M9=1 TO LEN(H£)
5030 P1=P1★16
5040 P2=ASC(MID£(H£, M9, 1))
5050 IF P2<48 THEN 5090
5060 IF P2>57 THEN 5090
5070 P1=P1+(P2-48)
5080 GOTO 5150
5090 IF P2<65 THEN 5130
5100 IF P2>70 THEN 5130
5110 P1=P1+(P2-55)
5120 GOTO 5150
5130 P1=70000
5140 RETURN
5150 NEXT M9
5160 RETURN
READY
#

```

# Stock record by bubble method

by Paul Woolley

IN last month's article I described how to re-order a list of words using a Bubble Sort. Most commercial applications which require data to be sorted usually have the data organised as records. By a record I

mean a group of related data items, such as the details found on a payslip or stock list.

A stock record in a stock control

(continued on next page)

**ROBIN BAILEY ASSOCIATES**  
62 New Cavendish St.  
London W1  
01-637 0777

**PET EXTENSION MEMORY BOARDS and IEEE to RS232 INTERFACES**

Price and delivery on application  
**ROBIN BAILEY ASSOCIATES**

● Circle No. 170

**Special Introductory Offer**  
**Ohio Superboard II £275 inc.**  
**Complete Computer on a Board**  
**Featuring**

- \* 8K Basic in ROM
- \* K.C. Cassette Interface
- \* Modified for U.K. T.V. Standard
- \* 4K user RAM Plus 1K Display RAM
- \* Upper/Lower case plus Gaming Characters
- \* M/C Code Monitor in ROM
- \* QWERTY Keyboard
- \* Graphics

**8K RAM Version £315**  
Prices Inc. VAT + P & P.  
Extras:- 24K RAM, Minifloppy Interface  
Output Ports, Bus Extensions,  
Ass/Editor etc.

**C.T.S. I Higher Calderbrook**  
Littleborough, Lancs. OL15 9NL  
Tel. Littleborough (0706) 79332 anytime

● Circle No. 171

**TOPMARK Computers**

dedicated to  
**APPLE II**



**Simply the best!**

Full details from Tom Piercy on  
Huntingdon (0480) 212563 or circle  
enquiry card.

● Circle No. 172

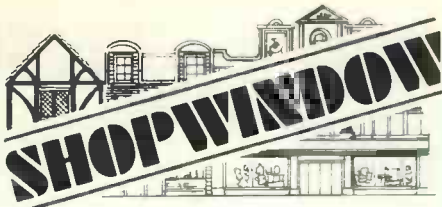

### HUMBERSIDE MICROPROCESSOR SERVICES THE COMPLETE INDEPENDENT SERVICE

Application areas:-

Business, process control, education,

Personal Computing

We can provide for you:-

Consultancy, training, supply,  
maintenance and software to suit  
your individual requirements

Including

Commodore P.E.T.  
M6800

Compec 202

and full ancillary equipment.

Microprocessor Services,  
139 Beverley Road,  
Hull

Humberside.

For further details ring (0482) 23146

● Circle No. 173

### CAMBRIDGE COMPUTER STORE

East Anglia's leading computer and  
electronics store offers you:

**TRS-80**  
**APPLE II**  
**N-S HORIZON**  
**CROMEMCO**  
**NASCOM-1**

Our stock includes a vast range of  
components as well as computer books  
and magazines.

Our store is open 6 days a week from 9-5-30 with  
demo. systems always in operation — We offer  
a professional standard of advice and after-sales  
support and we're ready to discuss your  
application any time.

**CAMBRIDGE COMPUTER STORE**  
1 EMMANUEL STREET  
CAMBRIDGE (0223) 68155

● Circle No. 174

### Dateline

Psychologically accurate  
introductions lead to:-

- Pleasant friendships
- Spontaneous affairs
- firm & lasting relationships
- including marriage  
all ages, all areas.

free details:

Dateline Computer Dating  
Dept (PCI)  
23 Abingdon Road  
London W8  
Tel: 01-937 6503.

● Circle No. 175

(continued from previous page)

application may comprise part number, description quantity in stock, unit price and location in a warehouse. Such records normally are stored in part number sequence but if, for example, there is need for the data to be printed in warehouse location number sequence, the data will have to be sorted.

To perform a bubble sort the data has to be in memory, and because each record is made up of several items of data a two-dimensional array (table) is required to hold the records. Using the record suggested previously, the table may be shown pictorially.

\$(n,5)

(1)	Part Number	Description	Quantity In Stock	Unit Price	Warehouse Location
(2)					
(n)					

There are five data items to a record and the maximum number of records is denoted by n.

The chosen data item which decides the sorted sequence is known as the key, which in this example is warehouse location.

One way of performing the sort might be to compare keys and when two have to be exchanged, swap over the other four data items in each record at the same time. This unfortunately, would result in more time being spent moving data than is acceptable.

The solution I propose requires the key to be put into another array with the position of the record—row number in the first array. The key is sorted and when the warehouse number is moved within the table, the row number is moved at the same time.

These tables may be shown thus:

D\$(n,4)

(1)	Part Number	Description	Quantity In Stock	Unit Price
(2)				
(n)				

I(n,2)

(1)	Row No.	Warehouse Location
(2)		
(n)		

RUNNH	PRODUCTG	13	28.47	1006
3166	PRODUCTC	5106	0.60	1990
1507	PRODUCTF	72	0.28	2004
2086	PRODUCTB	27	9.11	2872
1429	PRODUCTD	28	2.18	4878
1861	PRODUCTA	100	1.25	7168
1426	PRODUCTE	87	5.00	9001
1943				
READY				

Records are usually made up of a mix of alphabetic and numeric data which could necessitate the use of three arrays if numeric items are to be processed. One array would hold alphabetic data, the second would hold numeric data and the third would hold the keys.

In my example, I wish to sort only the data so that it can be printed in warehouse number sequence. After sorting, the array holding the keys is used as an index to access the second array holding most of the data. The data to be used is:

Part No.	Description	Qty in Stock	Unit Price	Location
1426	Product A	100	1.25	7168
1429	Product B	27	9.11	2872
1507	Product C	5106	0.60	1990
1861	Product D	28	2.18	4878
1943	Product E	87	5.00	9001
2086	Product F	72	0.28	2004
3166	Product G	13	28.47	1006

It can be seen from the listing that the sort routine needed only a few alterations so that it handles tables instead of a list.

```

LISTNH
10 REM                                     BUBBLE SORT
20 REM
30 REM                                     CONTROL
40 DIM D$(7,4), I(7,2)
50 GOSUB 100 !INPUT
60 GOSUB 200 !SORT
70 GOSUB 400 !PRINT
80 GO TO 600
100 REM                                     INPUT ROUTINE
110 FOR R=1 TO 7
120   FOR C=1 TO 4
130     READ D$(R,C)
140   NEXT C
150   LET I(R,1)=R
160   READ I(R,2)
170 NEXT R
180 RETURN
200 REM                                     SORT ROUTINE
210 FOR P1=7 TO 2 STEP -1
220   LET T2=(P1,2)
230   LET F=0
240   FOR P2=1 TO P1
250     IF T2>I(P2,2) GO TO 300
260     LET T1=I(P2,1)
270     LET T2=I(P2,2)
280     LET T=P1
290     LET F=1
300   NEXT P2
310   IF F=0 GO TO 370
320   LET I(T,2)=I(P1,2)
330   LET I(P1,2)=T2
340   LET I(T,1)=I(P1,1)
350   LET I(P1,1)=T1
360 NEXT P1
370 RETURN
400 REM                                     PRINT ROUTINE
410 FOR R1=1 TO 7
420   PRINT D$(I(R1,1),1),
430   PRINT D$(I(R1,1),2),
440   PRINT D$(I(R1,1),3),
450   PRINT D$(I(R1,1),4),
460   PRINT I(R1,2)
470 NEXT R1
480 RETURN
500 REM                                     DATA SECTION
510 DATA 1426,PRODUCTA,100,1.25,7168
520 DATA 1429,PRODUCTB,27,9.11,2872
530 DATA 1507,PRODUCTC,5106,0.60,1990
540 DATA 1861,PRODUCTD,28,2.18,4878
550 DATA 1943,PRODUCTE,87,5.00,9001
560 DATA 2086,PRODUCTF,72,0.28,2004
570 DATA 3166,PRODUCTG,13,28.47,1006
580 RETURN
600 END
READY

```

(continued on next page)



(continued from previous page)

This method of sorting records is not difficult to program but is slow in operation. The other problem in using the bubble sort is that, as all the data is held in memory, the quantity of data which can be processed at any one time is dependent on the amount of free space.

This is possibly one argument for getting as much memory as possible when buying a micro for business applications. It is possible to use the bubble sort with

quantities of data larger than memory free space provided that some backing store is available; unfortunately it involves a much greater processing time.

If backing store is available a different sort technique can be implemented which requires only a small amount of memory space. □

*In the Kim project article in Issue 4, the word resistor appeared instead of register in several instances.*

## Epic games— some ideas

by Nick Hampshire

WHEREVER there is a computer you will find at some time or another people playing games on it. To many, this is a waste of computer time but there is no doubt that playing games can be a mentally stimulating and totally absorbing experience.

Computer games are of all kinds from the very simple to the highly complex. The simple games are mastered quickly by the average person and, once mastered, lose most of their attraction. This accounts for the fact that the classics among computer games, like chess and Startrek, are long, complex and far from predictable, and as such are never lacking in fascination or challenge.

### Real experience

A group of games which fall into this category are the so-called epic games. The real classic of them, known only to those with access to large machines, is Adventure, written by Will Crowther in Fortran and occupying more than 120,000 words (36-bit) on a PDP-10.

I would suggest strongly that anyone with the opportunity should play Adventure; it can be a real experience.

There is a common structure upon which all epic games are founded, drawing on the psyche and folk tradition of the player. The player is involved actively and is identified as the central figure, a hero of national, international or galactic importance.

### Like a book

The setting for the game is equal to the importance of the hero and is often drawn from the world of fantasy. Equally, his opponents and allies are often endowed with supernatural powers and are drawn from the world of fictional literature.

The game usually involves our hero in a quest in which he must overcome great difficulties and perform great deeds to

achieve his goal. Thus Adventure involves the player in exploring a labyrinth of caves which may have between 25 and 100 rooms. As you explore, you will encounter treasure, magical objects, and assorted demons; you will find it advantageous to take some of the objects you find with you as they will help you later in your journey.

Since the result of any action you take depends on all your previous actions, this game is like a book with an infinite number of plots but the same basic theme.

The program for any epic game can be very complex, both factors which tend to rule out the possibility of writing such a program for a small machine like the Pet. This is not necessarily true, however, as a shortened version could be written for such machines by using techniques to reduce program space drastically.

### Narrative

Obviously, one can use all the traditional techniques like removing all REM statements, deleting all spaces and re-using the same variable for several purposes. Those are all techniques which would horrify the orthodox programmer but which result in the saving of a considerable amount of memory space.

By itself, however, this would not be enough to allow the running even of a very primitive epic program on an 8K machine, so we must look for other methods.

One could write the whole program in machine code but this is not to be recommended for any but the most ardent enthusiast, so a method is needed to reduce the size of the Basic program.

In an epic game we use a great deal of descriptive narrative, all of which is contained in Data statements. Reduction of the number of words in each description would result in a reduction of pro-

(continued on next page)

### Agents in SCOTLAND

for the  
COMMODORE  
PET



Robox (Office Equipment Sys-  
tems) Ltd.

84 Townhead  
Kirkintilloch  
Glasgow, Scotland

SALES  
SERVICES  
SOFTWARE

Telephone: 041-776-4388

● Circle No. 176

### 16K STATIC MEMORY BOARD

- S-100 Bus
  - 4K DIP Select Block Addressable
  - Cromemco Compatible Bank Select
  - Prime 2114-4 Static Memories
  - Solder Masked/Fully Socketed Board
- KIT WITH COMPLETE  
DOCUMENTATION—£220  
or FULLY ASSEMBLED AND  
TESTED—£240

\*\*2114-4 Static RAM Chips—8 up £5.50  
each \*\*

I. WALKER, S-100 repair service.  
S-100 Specialists,  
392 AKLAM ROAD,  
MIDDLESBROUGH. VAT and Postage  
inc. prices.

● Circle No. 177

### MICROCOMPUTERS ETC

PET 2001 8K RAM	£595
TRS80 Level I 4K RAM	£425
TRS80 Level II 16K RAM	£685
APPLE II 12K RAM	£895
SORCERER 32K RAM	£950
Mini Floppy Disk Drives	£350
RS232C/S100 Interfaces	From £90
Mini Floppy Disks (min 10)	Each £3
Expander Black Box Printer	£350
SCI Screen Printer (for RTS80)	£425
National Panasonic Video Recorder	£690

TV JOHNSON GROUP  
78 Park St, Camberley,  
Surrey, GU15 3PF  
(callers by appointment)

Telephone 0276 28333  
(plus answering machine evenings/weekends)

Evenings 0252 721094

● Circle No. 178

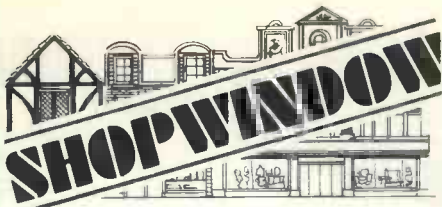

## TRS-80 Software

Business, hobbyist, games and general software including inventory-control file-handling and mailing-list. Level 1 and 2. Mostly imported from America S.A.E. for list.

**A. J. Harding**

28 Collington Avenue,  
Bexhill-on-Sea, E. Sussex.  
Tel: 0424 220391

● Circle No. 179

### One Day Courses on the Business and Professional Use of Micro-computers

Held in a pleasant rural setting less than 2 hours from London. Course fee of £18 includes lunch and full documentation. Full range of equipment demonstrated. Also SWTPc equipment, with full software support available. (for TRS-80 software service, SAE please.)

**PROTECHNIC**  
Yarwell, Peterborough  
Tel: (0780) 782746

● Circle No. 180

### MAILING SERVICES

Computer held files, Selected outputs on labels, letters, envelopes, Sorted for Mailing Rebate, Complete Mailing Shots Assembled & Posted, Coupon Responses, Order Files, Media Analyses etc.  
NLDS, ROTHWELL, LINCOLN  
0472-89346/7

● Circle No. 181

NASCOM 1 : Kit £197.50 + VAT  
: fully-built and tested  
£247.50 + VAT

SUPERBOARD II : fully-built and tested  
£284.95 inc VAT  
Ohio Scientific.

8K basic, 4K Static RAM 1K dedicated video memory, 53-key keyboard, upper and lower-case, graphics and gaming characters.  
for details: NIC Models, 27 Sidney Road, London N22 4LP Tel. 01-889-9736

● Circle No. 182

(continued from previous page)

gram size. It would, however, reduce greatly the attraction of the program for any player. This method is not really feasible; if we look at the words used in Print statements through such a program we would find that about 70 percent of them are used more than once.

Since about 85 percent of the memory space used in an epic program is required for Data statements, the observation that so many words are used more than once provides us with a clue to a method for significant reduction in the size of our program.

Each of the most common English words could be assigned a one-character abbreviation; this results in the compression of the description stored in each Data statement. A table of words and their abbreviations is then used by a subroutine to expand and print the description in plain English on the screen.

### Vocabulary

Thus, on the Pet, a vocabulary of up to 126 common words could be used with one alphanumeric or graphics character for each word. Some words, however, would occur only once and it would be desirable to leave those words in their correct position in the Data statement. This could cause problems, since the printing and expansion subroutine would not recognise that word but only the individual letters of the word, and instead of printing that word would print a chain of words for which each individual letter was the abbreviation. To examine this problem let us look at an example:

The English sentence: "This is an example of a sentence containing an unusual word"

The vocabulary with associated abbreviations:

This - A	is - B	an - C
example - D	of - E	a - F
sentence - G	containing - H	word - I

A Data statement containing this condensed sentence would then appear like this:

5630 DATA "ABCDEFHGHC7UNUSUAL"  
and "This sentence is a new example"  
becomes 5640 DATA "AGBF3NEW D"

Whenever a word not in the vocabulary occurs, it is preceded by a number indicating the number of letters in that word—thus "7UNUSUAL" and "3NEW". The expansion subroutine now can be constructed easily to recognise words contained within a string of abbreviations. This method of text compression could save as much as 1,000 bytes on an 8K program.

The use of a vocabulary opens another interesting possibility in writing epic-type games programs. This is to synthesise the text output by the program and thus produce an almost infinite variety of sentences.

The trick is to arrange the vocabulary into groups of words or phrases where the contents of each group could all be used in place of each other in a piece of text. Thus, instead of a piece of text we have a

series of pointers to groups of words or phrases; the broad meaning of the sentence can thus remain the same but the detail and words differ every time it is used.

Which word or phrase is selected from a group can be determined by a random number generator or by a form of weighted preference. The weighted preference method would probably be best since, if properly designed, it would eliminate some of the grammatical problems which can occur during sentence synthesis.

These ideas, I hope, will be of use to readers who may be encouraged to try to write an epic game, but I also hope that I have given some idea of the trend in computer games, since I am sure that as the price of memory and mass storage devices like discs falls, it will not be long before we can all play Adventure on a home computer.

Perhaps even more interesting is the possibility of extending the principle of the epic game to produce the "electronic novel"—the ultimate in escapism; no longer does the reader identify himself with the hero—he or she is now the hero.

With an infinite amount of memory, high-resolution colour graphics and voice input and output, it is a very interesting consumer market possibility within the next 15 years, not to mention an equally interesting challenge for a new generation of authors.

## Dams items for Pet

DAMS of Liverpool not only stocks other people's equipment but also produces its own accessories for the Pet system. They include a joystick unit, page printer and 625 external video adaptor.

The joystick with its machine code program gives full-control of screen printing, games and position-sensing. Averaging routines in the software improve stability and accuracy and more than one unit can be connected simultaneously.

The page printer unit allows a standard ASCII printer running a 20mA loop interface to be driven by the Pet. A machine-code program causes the screen to be copied to the printer, though not the special Pet graphics.

The video adaptor allows the Pet screen to be displayed on a standard UHF television set (tuned to channel 36), by connection to the aerial socket only. A 2M co-ax lead and plug are supplied. Internal adjustments, factory pre-set to standard TV, allow connection to a wide variety of models.

All three pieces of equipment have edge connectors and cables, cost £25 plus VAT, and have a delivery of 2-3 weeks.

Dams (Office Equipment) Ltd, 30/36 Dale Street, Liverpool L2 5SF.



# PPX-Plus is universal in concept

If the concept of a truly universal programmer, using swappable personality modules to interface with different machines, makes you think of some demon-coder with electrodes in his head, you're probably in the wrong business.

Either that, or of much too literal cast of mind to cope with the Stag Electronic Design personification of its PPX-Plus firmware programming system.

PPX-Plus can program any programmable device, such as Proms, Fplas or single chip microprocessors, in any device technology.

It consists of a mainframe containing power supplies, drive circuits, interface electronics, a VDU and keyboard, controlled by a microprocessor CPU.

The 'personality' module, which matches the programmer to the device to be programmed, is inserted at the front of the machine, making it extremely easy to convert from one device to another. The module contains specialised circuitry and device-specific information, such as voltages and timings.

Most of the electronics for doing the programming remains in the mainframe of the PPX-Plus. The software is divided into two operating systems, one controlling the programming of Proms and Pals, and the other of Fplas, Fpgas, Fpls's and so on. The appropriate operating system is automatically chosen by the software in the 'personality' module.

The information to be programmed into a device is stored in the RAM and may be loaded via an 8-bit parallel interface, a serial RC232C or 20mA current loop interface, from a master device of from the keyboard.

There is a number of input formats,

including those of the most common microcomputer development systems and they can be selected from the keyboard. If interfaced to an MDS via its RS232C interface, the PPX can input directly from the MDS, avoiding the need for punched tape.

Data in the RAM may be output via the parallel or serial interface to generate hard-copy printout or punched tape.

Editing of data in the RAM is achieved by changing it via the keyboard, or using a re-locate mode to move around blocks of data.

Program patterns can be checked easily by using a list mode to display the contents of master or slave VDUs, and the RAM.

Before programming a device, the PPX first will check it is unprogrammed. It then programs it to the manufacturer's recommended specification. When programming is complete, the device is verified against the RAM using the supply voltages and leads specified by the manufacturer.

Normally all the locations of the device are programmed but should it be desired to program only part of it, the address or P term range to be programmed can be set manually. The programmer will then only check, program and verify the locations within this range.

The PPX-plus can operate as a powerful stand-alone system, or as a terminal to a microcomputer development system or minicomputer. It is able to support a variety of peripherals, such as tape readers, punches, teletypes and printers.

Stag Electronic Designs is at Fellowship House, Tewin Road, Welwyn Garden City, Herts.

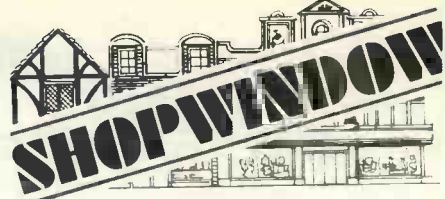

## HAPPY MEMORIES

ASCII KEYBOARDS £49  
£1 p&p. Cursor Kit £2.50

All 128 ASCII characters, parallel output, 2 key rollover, Alpha lock, Auto-repeat, Two user-definable keys, positive and neg. strobe, All on 12½ x 6 inch PCB. Add-on five key cursor kit for up, down, left, right and home available. Send SAE for data sheet.

Science of Cambridge Mk 14  
Set of 18 Texas low-profile DIL sockets 280p

21L02 450 ns 89p, 16 up 86p, 64 up 83p  
21L02 250 ns 110p, 16 up 107p, 64 up 104p

2114 450 ns 550p, 4 up 525p  
2114 300 ns 625p, 4 up 600p

4116 DRAM 1050p, 4 up 1000p  
2708 450 ns 675p, 4 up 650p

Texas low-profile DIL sockets:

Pins 8 14 16 18 20 22 24 28 40

Pence 10 11 12 17 18 20 22 28 38

Antex 1mm bits or CX17 or CCN irons 45p

Happy Memories,  
5 Cranbury Terrace,  
Southampton, Hants  
SO2 0LH

All prices include VAT. Add 20p postage except where shown. COD available at cost.

● Circle No. 183

## GRAFFCOM PROFESSIONAL BUSINESS SYSTEM

We can offer a complete Turnkey installation with everything including evaluation, system design, installation and training.

Our range of systems handles payroll, accounts, inventory, invoicing, financial planning, plus any specialised applications you require.

Why not contact us Today?

### GRAFFCOM

52 Shaftesbury Av., London W1  
01-734 8862

## GRAFFCOM

● Circle No. 184

## NORTH LONDON AGENTS FOR PET

For the best deal, come to the experts. Professional advice given in setting-up your own system.

### DAVINCI COMPUTERS Ltd.,

Classic Offices, rear of Classic Cinema,  
Hendon Central,  
London NW4  
01-202 4646

● Circle No. 185

### The **SORCERER**

comes north for a demonstration of this flexible and reasonably-priced computer, contact (**Basic Computing**) Telephone Keighley 65094 (W. Yorks).

Our experience of Business applications, together with the capabilities of the **SORCERER**, can give you a very effective small business system.

● Circle No. 186

### Mini Computer



### Cassettes at incredibly low prices

Buy direct from the manufacturer and on top quality mini-computer cassettes. Thousands sold every month.

Send for full details to:

**PROFESSIONAL TAPES Ltd, Cassette House,**  
329 Hunslet Road, Leeds, LS10 1NJ.  
Telephone: Leeds (0532) 706066

● Circle No. 187

### CHESS CHALLENGER '10'

PRICE £199.95 for "THE WONDER" CHESS GAME  
Z80A MICRO PROCESSOR

SOME OF ITS FEATURES INCLUDE:

1. Ten levels of play including 'Mate in two'.
2. Levels changeable during game.
3. Random Computer Responses vary Every Game.
4. Play from the bottom board or the top of the Board. Choose either black or white.
5. Does not permit illegal moves. Never makes an illegal move according to all the rules of chess.
6. Position verification by computer memory recall.
7. Plays opening defences from chess books, i.e. Sicilian, French, Ruy Lopez, Queen Gambit declined.
8. Analyses as many as 3,024,000 board positions.
9. Audio Feedback: Single tone each time you press a key: Double tone when computer responds.

TI Programmable £49.45 U.K. Microvision £99  
International Microvision £149.45

Microprocessor Draughts and Backgammon also available  
sae for details.

CBM Pet 2001K, Texas TI59, 58 sae for details.

**KRAMER & CO**, 9 October Place, Holders Hill Road  
London NE4 1EJ Tel: 01-203 2473

Mail order only, callers by appointment.

● Circle No. 188

### Dyna-Byte

fully assembled  
burned in S100

16K Dynamic	RAM	£198
16K Static	RAM	250ns £271
16K Static	RAM	450ns £266
32K Static	RAM	250ns £506
32K Static	RAM	450ns £470

80 × 24 video terminal, just add key-board and monitor £177.

Cable set for video terminal £7.20

Postfree. Add 8% VAT to all prices.

S.W.C. Electronic distributors, P.O.  
Box 30, London E.4.

● Circle No. 189

# Retinal display is Magic Wand for £5

by **NICK HAMPSHIRE**

AN EXHIBIT mysteriously entitled the Magic Wand attracted a great deal of attention at the West Coast Faire in Los Angeles (*Practical Computing*, January, 1979). The reason for the interest lay in the fact that the exhibit was for a very ingenious, low-cost alphanumeric computer display.

To look at, it was eight small light emitting diodes on the end of a piece of spring steel. Unless one knew, one could well be excused for thinking it a leg-pull in claiming that it was a computer display—until the piece of spring steel was deflected, making it oscillate so that the LEDs traversed an arc a few inches long.

Then, instead of the LEDs appearing to be on continuously, a line of text appeared in the area traversed by the diodes. What one was seeing was an example of what is known as a retinal display.

Retinal display is a perfect example of a new technology being coupled with an old principle to create a new field of applications for that technology. The principle is that on which the whole of the film industry relies—the fact that the eye retains an image for a short time after the image has been removed.

Thus, if you move a light rapidly across your field of vision, rather than seeing a moving point of light you will see a line of light. The image at any one instant is retained long enough in the retina so that it merges with all the other images which follow in the fraction of a second it takes to move the light.

### False image

The result is a false image. That effect is produced with one LED and the piece of oscillating spring steel. What is seen is an arc of red light apparently hanging in the air.

A LED has a great advantage over an incandescent lamp; it can be switched off and on very rapidly without having to warm up or cool. This fact makes it possible to play some interesting games with LED and spring steel. If the LED is turned off and on rapidly, instead of an arc of light there is a series of dashes. If the frequency is increased a chain of dots of light is produced. Further increase in frequency returns us to what appears to

be an arc of light. It is this ability to produce a chain of dots of light which is the foundation of this display device.

Placing eight LEDs one above the other on the end of the piece of spring steel and turning them off and on synchronously at a certain frequency gives a display of eight parallel chains of dots of light. This gives a matrix of dots and is the basis on which an alphanumeric display could be constructed.

To do so, certain particular dots within the matrix would have to be turned off to produce visible characters, and to do this a computer is essential. Each column in the matrix is formed by the row of eight LEDs all on at the same instant. Not all the LEDs, however, need be on during the on phase—that would produce an off dot in the matrix. Thus by turning on or off the LEDs selectively in a precisely-timed manner, a display can be produced of, say, a line of text.

### Simple display

A parallel eight-bit user port on the computer can be connected via some driver circuitry to the eight LEDs, allowing the timing and control to be done entirely by software. One further piece of circuitry is required to sense the reversal of direction of the piece of spring steel at the end of each sweep, this can be done by an inertial switch connected to an input line.

An inertial consists of a cantilevered piece of wire of the correct mass and flexibility, which is forced to make a connection at the end of each sweep by its own inertia. That input triggers the computer after a suitable delay to display the line of text. For optimum viewing, this input should occur not less than 25 times per second.

The software in its simplest form consists of outputting to the parallel port, byte by byte, the contents of a block of memory. If it is required to display a line of 40 characters, with each character occupying an 8 × 8 matrix, it would require 320 bytes of memory. Character generators could be built into the software but, of course, this kind of display is not limited to alphanumeric characters; by increasing the number of I/O ports and

(continued on next page)

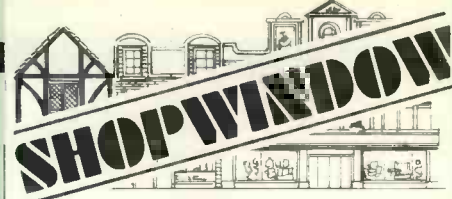

(continued from previous page)

LEDs, a high-definition graphics display could be constructed.

One is not confined to placing the LEDs on the end of an oscillating strip of spring steel. The display can be scanned by other mechanical means. Thus the diodes can be mounted on the edge of a rotating drum, or a radar-type PPI display can be constructed by placing a

line of diodes along the radius of a rotating disc.

Alternatively, this display also works if the viewer moves past the display, a fact which opens-up some interesting advertising applications.

Whatever technique is used it should provide the computer enthusiast with a novel and unusual display for even the simplest machine. □

## Essential items

AN ESSENTIAL piece of equipment for any serious hobbyist is an oscilloscope. Two British-made instruments providing high quality at a price most people can afford are now available from Calscope.

The Super 10 dual-trace oscilloscope has two vertical amplifiers with 10 mV/cm sensitivity and a band width of DC-10 MHz (3 dB) and 10 MHz can be displayed over the full screen area, a feature not usually available with low-cost instruments.

### Reliable

Complementing the versatile amplifiers is a fully-triggered timebase with sweep ranges from 200 ns/cm to 100 nS/cm. Stabilised power supplies ensure reliable performance and an unmatched accuracy of three percent for both voltage and time measurement.

The Super 6 single-trace has a vertical amplifier sensitivity of 10 Mv/cm to 50 V/cm

in 12 calibrated ranges; again, the bandwidth of 6 MHz can be displayed over the full screen area. A versatile triggered timebase with 16 calibrated ranges of 1 μS to 100 Ms/cm completes the equipment. The Super 10 costs £219 plus VAT, and the Super 6, £162 plus VAT.

Both instruments are fully transistorised, provide excellent performance parameters and are always calibrated. The fully-triggered timebase guarantees that the operator not only obtains 100 percent steady reliable trigger from sine and square waves, but also from more complex wave forms such as pulse trains, while the instrument maintains its calibration.

Calscopes are available from Maplin Electronics Supplies, PO Box 3, Rayleigh, Essex; Audio Electronics, 301 Edgware Road, London W2; and Marshalls Electronic Components, Kingsgate House, Kingsgate Place, London NW6. □

## Advertisement Index

Abacus Computer Services	36	Keen Computers Ltd	30
Airamco Ltd	21	Limrose Electronics	57
Almarc Data Systems	16	Lock Distribution	49
		Lotus Sound	7
Beys Logic Ltd	64	LP Enterprises	8, 15, 63
Byte Shop, The	4	Lyme Peripherals	66
		Microdigital	34
CCS Microhire	24	Microsolve Computer Services	58
Comart Ltd	5	Millhouse Designs	66
Commodore Systems Division	13, 48		
Comp Computer Components	79	Nasco Sales Ltd	6, 8, 10, 12, 14
Compelec Electronics	50	Newbear Computing Services	64
Computerbits Ltd	10		
Compuettes	2	Online Conferences Ltd	58
Computer Workshop	80	Optronics	16
		Padmede Ltd	20
DAMS	36	Pelco (Electronics) Ltd	66
Data Efficiency Ltd	63	Personal Computers Ltd	63
De Boer Elektronika	44	Petalect Ltd	10
		Petsoft	16
Electronic Brokers Ltd	8	Rair Ltd	22
Electrovalue Ltd	34	Research Machines	17
Equinox	6, 20, 62		
Euro-Calc	6	Shelton Instruments	14
		Sintron Microshop Ltd	11
Factor One	44	Sumlock Bondain	39
Games Workshop	34	Tangerine Computer Systems	14
Gate Microsystems	58	Technical Book Services	20
H.L. Audio Ltd	18	Video Software	64
Infotech International	26	Xitan Systems	36
Isher-woods	12		
Jade Computer Products	9		

## AT LAST

The COMP NASCOM S-100 expansion kit for STATIC RAM and EPROM boards. Ex-Stock available now £47.50 + 8% VAT

COMP brings to you an S-100 motherboard (with full buffering) to connect to your NASCOM 1. This easy-to construct kit contains all that you need to add-on S-100 STATIC RAM 16K or 8K and EPROM boards.

ITHACA 8K STATIC S-100 memory-boards. Fully-assembled, tested and guaranteed £110 + 8% VAT.

16K TRS-80 upgrade kit. Everything you need to up-grade your TRS-80 to a 16K system. Only tool required is a household screwdriver. £99 + 8% VAT



Please make cheques and postal orders payable to Comp, or phone your order quoting BARCLAY-CARD or ACCESS number.

### COMP COMPUTER COMPONENTS

14 STATION ROAD

NEW BARNET

HERTFORDSHIRE

Tel: 01-441 2922

Close to New Barnet BR Station—Moorgate Line

Open 10-7 Monday to Saturday

# A PRACTICAL GLOSSARY

Continuing the terminological gamut with F

## Failsoft

Failsoft is essentially the same as graceful degradation but provides less scope for double-entendres. Failsoft is a noun. As an adjective, a system is failsoft if it switches itself off in the event of breakdown, so that no important data is lost. Failsoft usually implies that things can be re-started from the point at which the system broke down. Some machines fail softer than others.

## Fairchild

The Fairchild Instrument Co is one of the big fish in the micro sea, though like many large corporations it has not exactly seized the opportunities open to it, which is why Fairchild has a perfectly respectable line of microcomputers (deriving from the F8) without setting the world on fire.

That might be about to change. Fairchild has suddenly become very active in this area, and is in the process of litigation with Data General, whose Nova instruction sets are used by Fairchild's latest 16-bit micros.

Fairchild's other significance lies in its proximity to Silicon Valley. As a result, its alumni have spawned most if the top micro and mini companies in the area, including Intel.

## Fault

You will not believe this, but a fault is what happens (or doesn't happen) when something doesn't work. In practice, the term usually refers to a *physical* malfunction, which means a hardware defect like a short-circuit, a duff piece of soldering or a broken wire. By contrast a bug (qv) is usually a fault specifically in software.

## FDX

Conventional abbreviation for full duplex (qv).

## Feed

What happens to the sea-lions at 1430 hrs. Or how cards and paper get into the computer. A card feed is the mechanical device which (wait for it) feeds cards into a card reader. A paper feed is the mechanism whereby paper is fed into a printer. A *front-feed* is a particular device which allows you to stack a pile of single sheets on a printer, dropping a sheet at a time automatically into the printer.

## Feedback

The easiest way to get feedback is to try giving an obstreperous infant liver and spinach broth for its din-dins.

The word also has two less frivolous meanings. Feedback is

what occurs when an output impulse is picked up and fed back into the circuit as input. It happens with any electrical transmission device—frequently between electric guitars and amplifiers. A big hand, please, for Jimi Hendrix and Pete Townsend who pioneered its deliberate use in that department.

A second, more abstract, meaning of feedback is the getting of information from one operation which can be used either to alter that first operation or to initiate another. This is why the letters page of *Practical Computing* is called Feedback.

## Ferranti

Historically significant in Britain. Ferranti's present interest is in military and process control systems with its Argus minis and the F100 micro, which was one of the earliest 16-bit micros.

## FF

Conventional abbreviation for form feed.

## Field

A file consists of records, a record consists of fields. It is easy enough to produce a logical definition of a field—something like "an area where data of a given type will be found for processing or storage as a single entity". In practice, the definition is likely to be practical and obvious. For instance, membership records might comprise fields for name, address lines, membership number, and membership fees paid. Or you might set up the system at a greater level of detail plus one field for surname, two for first names, one each for house number, street, town, county, postcode, country . . . and so on.

## FIFO

I smell the blood of a jargon-monger. This whimsical term stands for "first in—first out"—a method of storing items of data so that the first one entered is the first one retrieved. The average use of the term is for a FIFO buffer, which is typically a sequential list of things queuing for processor's attention—instructions to be executed, perhaps, or events in the outside world.

## Firmware

Is it a corset? No. Is it a toupée adhesive? No. Is it a hardwired program? Yes. Firmware is essential software fixed in the computer in Read-only Memory (ROM). For example, the operating instructions may be held on ROM—as they are in the Pet; or a computer

which controls traffic lights may have its program permanently resident in the same way.

Because it is in ROM, firmware executes very quickly—getting instructions from ROM is much faster than from ordinary read-unit memory. Since it is difficult or impossible to alter the contents of ROM, firmware has to be *right* before it is committed to ROM.

## File

An attempt to organise related information; or a collection of records. In practice, a file in computer terms is the essential input for a processing program. Some systems require you to set up your programs as individual files; you read the (program) file into memory, and that file contains all the instructions you need. Data files contain all the data a particular program needs; a subscription program might use one file of subscriber records, another with subscription rates.

## Filing system

All but the smallest computers have system software which includes at least some method of organising files. The filing system lays down the rules about how you store and retrieve files. In particular, it tells you how to relate the organisation and structure of a file to the patterns of access, but for an exposition of this you'll have to wait for *indexed sequential* (qv).

## Fill

A field (qv) may be larger than the information you put into it. An address field, for instance, may be set up to cater for large addresses with up to seven lines of 35 characters apiece; so a short address won't take up all the space available. Some systems and some applications require at least some data in the unfilled area—so you have to "fill" it, usually with meaningless zeroes. This may also be called padding or packing.

## Fixed disc

Described at length under discs (qv); a fixed disc is non-removable. A fixed disc is usually a fixed-head disc, which means that each track in the disc gets its own read/write head. The alternative is moving heads, which move around the disc surface to reach the data required.

Obviously a fixed-head—or "head-per-track"—disc will provide faster access to data; equally obviously, they are considerably more expensive than other discs. You can't afford one and probably don't need one.

## Flag

Flag is what the editorial staff of this magazine do towards the end of the day. For a computer, a flag is a sequence of bits which signal the beginning and the end of a piece of data, or indicate something about it.

Typically, a flag is an indicator attached to a data field; it is likely to be a single bit position. For example, if you have a record to be printed you might set a flag to "1". Your print program would then hunt around the files looking for all records with the flag set.

## Flip-Flop

Woollies used to do good ones, and if you can afford them surf shops tend to have great flip-flops. The rest of us will have to make do with something along the lines of a bi-stable electrical component—which could be a toggle switch, or it could be a logic gate (qv). Forget it.

## Floppy disc

Floppy discs are, as the name implies, a flexible storage medium, rather like the plastic 45 rpm records given away as promotions. Each disc lives in a protective jacket; the read/write head passes through a slit in the cover. We discussed disc storage in depth under our disc entry.

Floppies are in a range of sizes from 5½ in. mini-floppies to double-sided, double-density, full-size floppies. A normal mini-diskette holds about 71KB; a double-sided, double-density mini holds four times that—280KB. Average 8 in. floppies go from a minimum of 250-315KB to a maximum of around 1.26 megabytes.

Access time for floppies is reasonably fast: they are not expensive; they are easy to handle and to store. Rumour has it that the hole in the middle bends, too.

## Flowchart

A flowchart is a graphic representation of a system or a program. As a concept it is brilliant. It is very explicit an easily understood description of what is happening—or what ought to happen, since flowcharts are usually produced after you have done some thinking but before you write any code.

It is difficult to over-estimate the importance of drawing a flowchart. Everyone should learn flowcharting before they learn a programming language.

Flowcharts use a number of conventional symbols. The important ones are "process" boxes and "decision" lozenges.

# THE SORCERER HAS ARRIVED

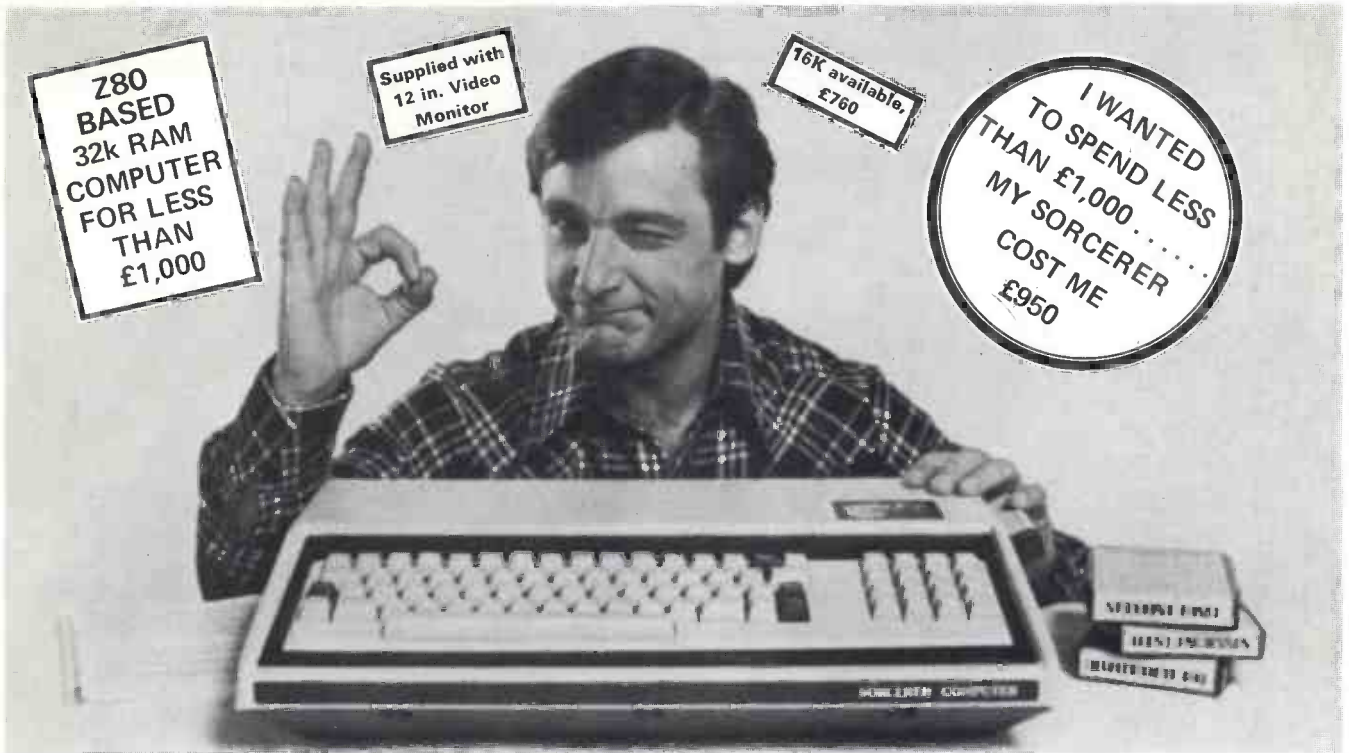

## Introducing the personal computer you've waited for. The Exidy Sorcerer.

I didn't buy my personal computer until I found the one that had all the features I was looking for. The Exidy Sorcerer does everything I wanted to do and a few things I never dreamed of.

It isn't magic. Exidy started with the best features of other computers, added some tricks of their own, and put it all together with more flexibility than ever before available. Presto! My reasons for waiting just disappeared.

**I wanted pre-packed programs.** Software on inexpensive cassette tapes for the Sorcerer is available from Exidy and many other software makers.

**I wanted user programmability** The Sorcerer's unique plug-in ROM PAC™ Cartridges contain programming languages such as Standard (Altair 8k\*) BASIC, Assembler and Editor (so I can develop system software), operating systems such as DOS (so I can also use FORTRAN and COBOL) and applications packages such as Word Processor.

\*Altair is a trademark of Pertec Computer Corp.

**I wanted Graphics,** and the Sorcerer is super. Its 256 character set — more than any other personal computer — includes 128 graphic symbols that I can define.

**I wanted high resolution video.** With 122,880 points in a 512 x 240 format, I get the most detailed illustrations.

**I wanted to display more information.** The Sorcerer displays 1920 characters in 30 lines of 64 characters — equal to a double-spaced typed page.

**I wanted a full, professional keyboard.** The Sorcerer's 79-key data processing keyboard provides designated graphics, the complete ASCII character set in upper and lower case, and a 16-key numeric pad.

**I wanted memory.** The 12k of ROM holds a Power-On Monitor and Standard BASIC; 32k of RAM is supplied on board.

**I wanted expandability.** Serial and parallel I/Os are built in, and the op-

tional 6-slot S-100 expansion unit lets my system grow.

**I wanted a computer that's easy enough for children to use.** I just connect my Sorcerer to a video display and a cassette tape recorder, and if I have any questions the easy-to-understand Operation and BASIC Programming manuals have the answers.

**I wanted to buy from an experienced Manufacturer.** In five years Exidy has become the third largest producer of microprocessor-based video arcade games.

**I wanted to spend less than £1,000.** (This is where COMP does a little magic). My Sorcerer cost me £950!

Now, what are you waiting for? Call COMP. on 01-441 2922 or write to

**COMP COMPUTER COMPONENTS**

14 Station Road,  
New Barnet, Herts. EN5 1QW.

(Price shown ex. VAT)

DEALER ENQUIRIES INVITED, A LIMITED NUMBER OF DEALERSHIPS STILL AVAILABLE.

# We're getting bigger to give you a better service

**We've opened a Sales and Customer Service Centre in London. And our new factory is fully operational. Southwest Technical Products provide a range of superb computer systems with technical backing second to none.**



#### **Systems**

To suit all types of user – OEM, process control, data handling, small business systems, and all accounting functions.

#### **Software**

Low cost packages for word processing, selective mailing, progress control and invoicing. Our Software Development Unit available to prepare programmes to customer specification.

#### **Training**

Inexpensive courses (at Dover Street): **BASIC** – programming for the businessman; microcomputers in **EDUCATION**; **WORD PROCESSING** made easy; **SOFTWARE DEVELOPMENT** – make your microprocessor work.

#### **Maintenance**

Comprehensive national service by Computer Field Maintenance Ltd.

**Sales Office: 38 Dover Street, London W1.**

**Tel: 01-491 7507 Telex: 268913.**

**Factory: 12 Tresham Road, Orton Southgate, Peterborough.**

**Tel: 0733-234433 Telex: 32600.**

# **SWT**

**the symbol of reliability**